

altech[®]

Breathing Systems

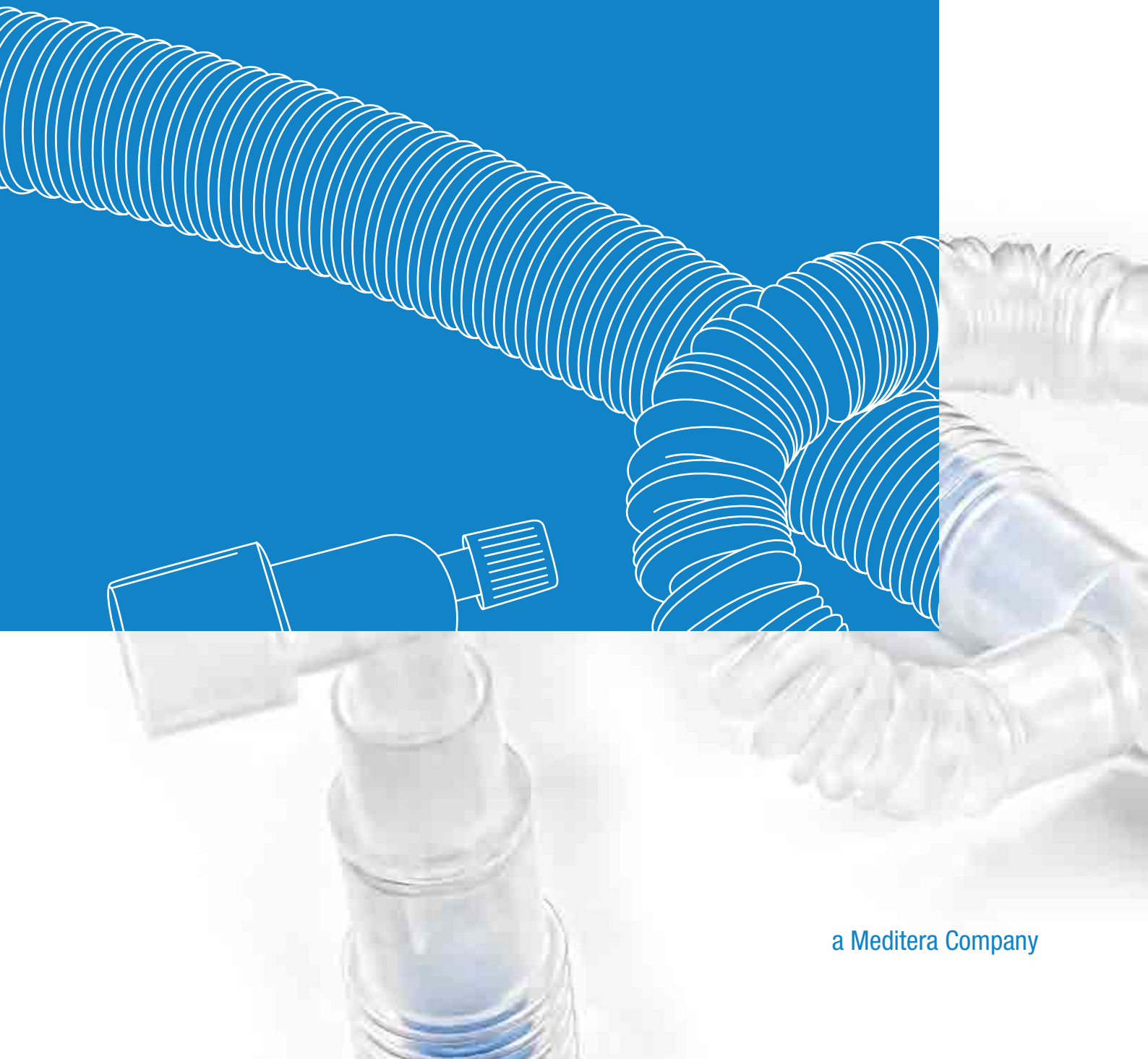

a Meditera Company



altech®

a Meditera Company

altech®

a Meditera Company

- Facility in Tire Organized Industrial Zone, İzmir
 - 60.000 m² total area
 - 30.000 m² production area
 - 6.400 m² Clean Rooms
- CE,ISO 9001 , ISO 13485 & ISO 14001
 - Injection Molding and Tube Extrusion
 - Design and Production of Molding
- Production and Assembling of Respiratory Disposables
 - Ethylene Oxide Sterilization Units





Company Profile

Our job is to make yours easier

Altera A.S. was founded in 1999 as a manufacturing company of Meditera Group by Pharmacist Atilla Sevincli. Since its foundation, Altera has been devoted to developing, designing and manufacturing range of respiratory products that meet market demands, top quality, good service and each day better quality. Our success is based on our knowledge.



The company is specialized in the healthcare sector and located in Izmir, Turkey. Altera is devoted to production and assembling of the Disposable Medical Consumables with the Altech® brand manufacturing in 11 clean rooms (10.000 and 100.000 class). The products are CE marked and comply with ISO 13485 & 14001

Altech stands for modern respiratory treatment of quality and safety when it comes to the care and treatment of patients

INDEX

Breathing Circuits

Catheter Mounts

Filters

Oxygen and Aerosol Therapy Products

Gas Sampling Lines

Masks & Resuscitators

Accessories

Certifications

10 - 31

34 - 35

38 - 41

44 - 45

48 - 49

52 - 53

56 - 64

65

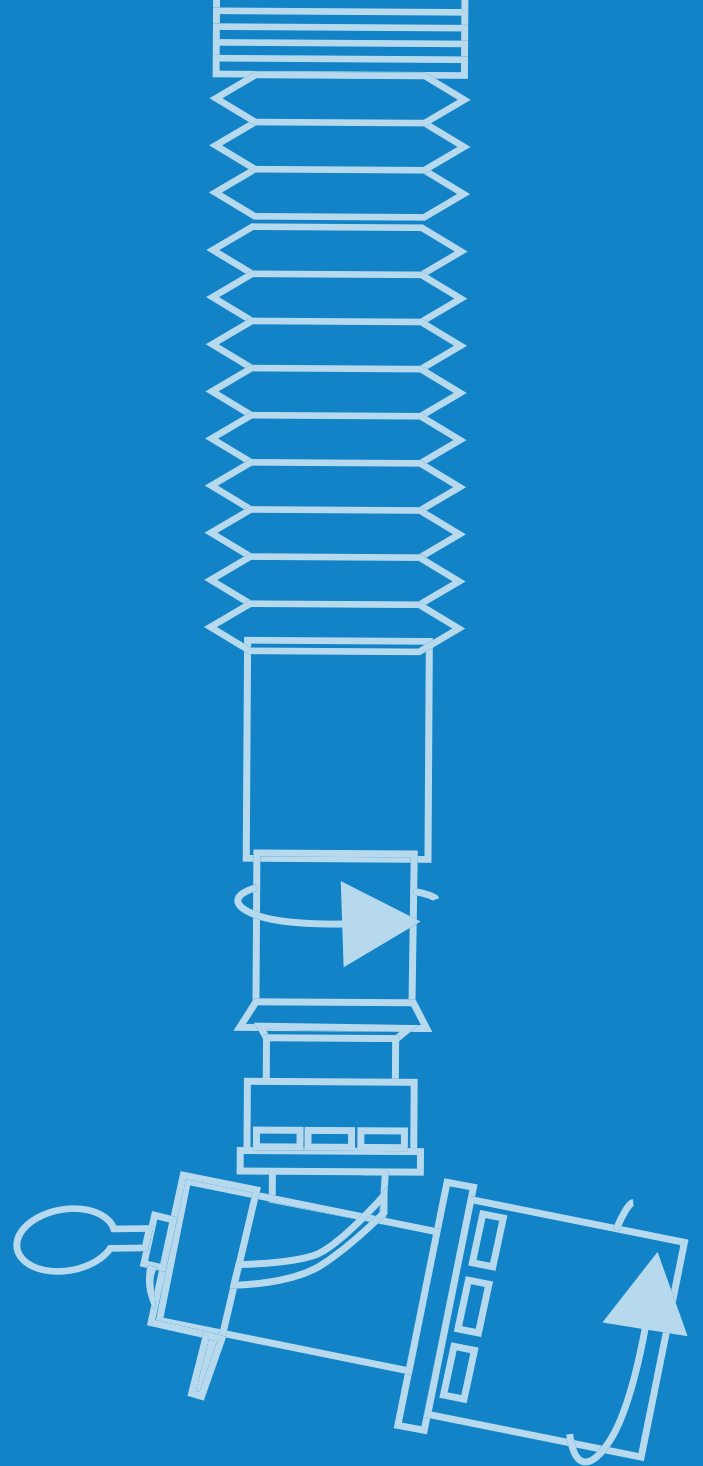



altech[®]

a Meditera Company

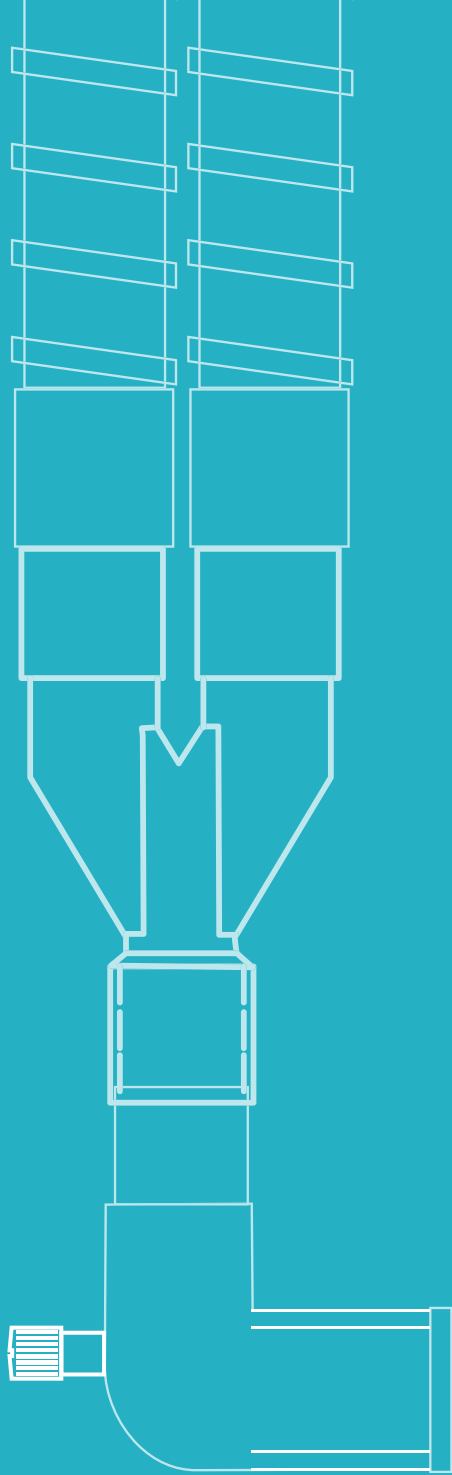

Breathing Circuits

Anesthesia Circuits

• Altech offers a wide range of anesthesia circuits available in different lengths and configurations for anesthesiology, operating and recovery room. We ensure to offer the proper anesthetic breathing circuit for you according to your clinical needs and requirements.

- Circuits are available in;
 - Different sizes: (Adult, pediatric and neonatal)
 - Different tubing types: Corrugated PE / Extendible PP / Smoothbore PVC
 - With Y & Elbow Connectors (with or without ports)
 - Sterile or Clean manufactured
- All circuits are manufactured in 10.000 or 100.000 Class clean rooms.
- All products are CE marked and comply with ISO 13485 regulations.



ANESTHESIA CIRCUIT

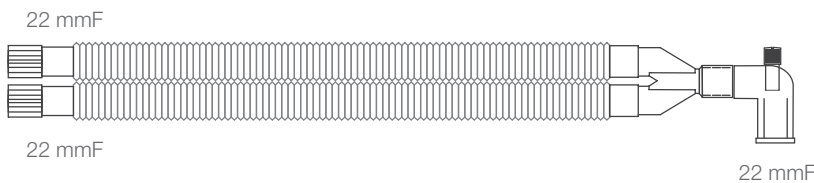

Corrugated			
	Length	Code	Qty/Box
Adult	160 cm/63"	AL-1100	40
Pediatric	160 cm/63"	AL-1400	50
Neonatal	160 cm /63"	AL-1700	50

Extendible			
	Length	Code	Qty/Box
Adult	160 cm/63"	AL-1300	70
Pediatric	150 cm/59"	AL-1600	70

Smoothbore			
	Length	Code	Qty/Box
Adult	180 cm /71"	AL-1200	40
Pediatric	150 cm/59"	AL-1500	50
Neonatal	150 cm/59"	AL-1800	50

ANESTHESIA CIRCUIT WITH LIMB

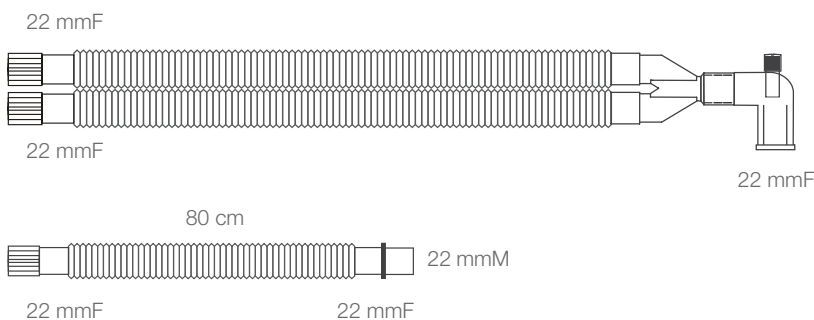

Corrugated			
	Length	Code	Qty/Box
Adult	160 cm/63"	AL-1101	30
Pediatric	160 cm/63"	AL-1401	50
Neonatal	160 cm /63"	AL-1701	50

Extendible			
	Length	Code	Qty/Box
Adult	160 cm/63"	AL-1303	70
Pediatric	160 cm/63"	AL-1603	70

Smoothbore			
	Length	Code	Qty/Box
Adult	180 cm /71"	AL-1202	30
Pediatric	150 cm/59"	AL-1502	50
Neonatal	150 cm/59"	AL-1802	50

Anesthesia Circuits



Flexibility – Corrugated Tube (Polyethylene)

- Lightweight and cost effective
- Directly bonded connectors to the tube for avoiding leakage risks
- Available in White and Blue Color

Adjust&Extend – Polypropylene (PP) Extendible Tube

- Extendible tubes may be extended up to 3 times their packed length and allow system to be set to the desired length and position optimising the compressible volume
- Extendible tubings maintain their position set by healthcare professional as long as desired thus minimise the strain on the airway connection
- Available in adult 22mm and pediatric 15mm sizes

Smooth Inside – Smoothbore PVC Tube

- Lower tubing compliance
- Transparent tube makes viewing tube inside easier
- Inner smooth surface allows easy drainage of condensed water and contributes to reduce the risk of interruptions in anesthesia,
- Soft, flexible connectors ensure a perfect seal with anesthesia machine inlet and outlet.

ANESTHESIA CIRCUIT WITH LIMB & BREATHING BAG

Corrugated

	Length	Code	Qty/Box
Adult	160 cm/63"	AL-1101-060	30
Pediatric	160 cm/63"	AL-1401-060	50
Neonatal	160 cm/63"	AL-1701-060	50

Extendible

	Length	Code	Qty/Box
Adult	180 cm /71"	AL-1303-060	70
Pediatric	150 cm/59"	AL-1603-060	70

Smoothbore

	Length	Code	Qty/Box
Adult	180 cm /71"	AL-1202-060	40
Pediatric	150 cm /59"	AL-1502-060	50
Neonatal	150 cm /59"	AL-1802-060	50

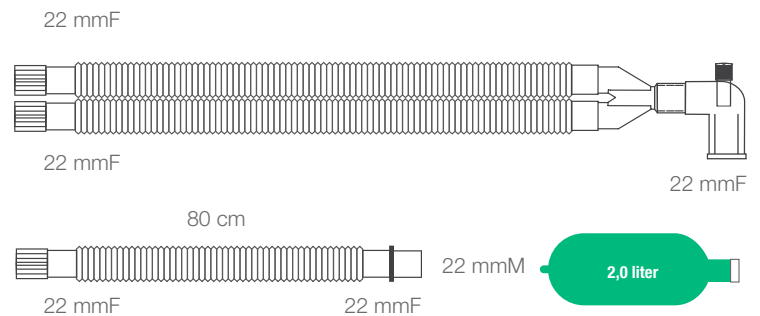

NITROUS OXIDE AND OXYGEN DELIVERY CIRCUIT

Extendible

	Length	Code	Qty/Box
Adult	300 cm /118"	AL-1300-100/9	60

Nitrous oxide is the most commonly used inhalation anesthetic in dentistry and is commonly used in emergency centers and ambulatory surgery centers as well to provide minimal and moderate sedation. The gas (equal parts of nitrous oxide and oxygen) is administered via a special circuit and inhaled by the patient using either a face mask or a mouthpiece.

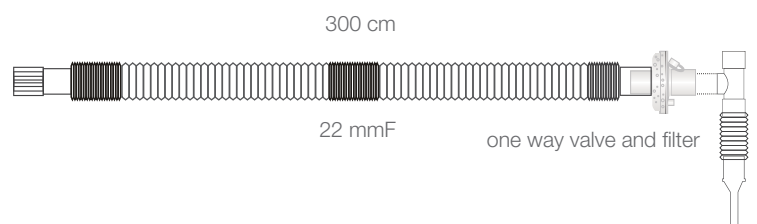

Anesthesia Circuits

Tailor Made Solutions

- Tubing lengths may be customized by the end user
- Complete package solutions depending on the clinical needs

Easy & Secure Connections

- 22mm Female machine inlet connectors ensures a secure fit to the anaesthetic machine. The soft, lightweight and flexible materias enhances a secure seal while still allowing ease of connection and disconnection.



ANESTHESIA CIRCUIT WITH LIMB BREATHING BAG / BACTERIAL-VIRAL FILTER

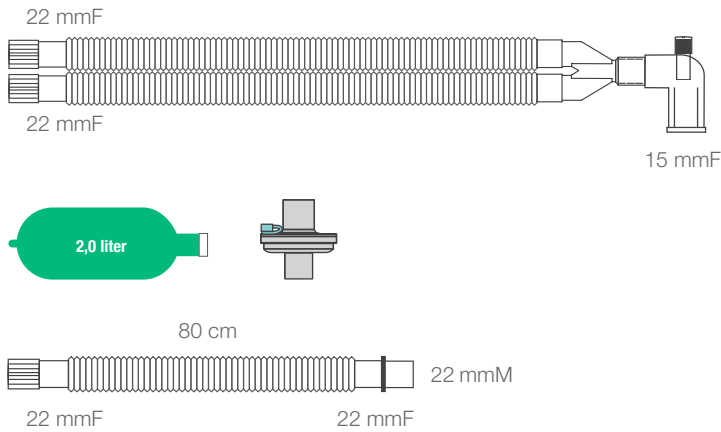

Corrugated

	Length	Code	Qty/Box
Adult	160 cm/63"	AL-1101-160	30
Pediatric	160 cm/63"	AL-1401-160	50
Neonatal	160 cm/63"	AL-1701-160	40

Extendible

	Length	Code	Qty/Box
Adult	180 cm/71"	AL-1303-160	50
Pediatric	150 cm/59"	AL-1603-160	60

Smoothbore

	Length	Code	Qty/Box
Adult	180 cm/71"	AL-1202-160	30
Pediatric	150 cm/59"	AL-1502-160	30
Neonatal	150 cm/59"	AL-1802-160	40

ANESTHESIA CIRCUIT WITH LIMB BREATHING BAG / BACTERIAL-VIRAL FILTER / MASK/CO2 SAMPLING LINE

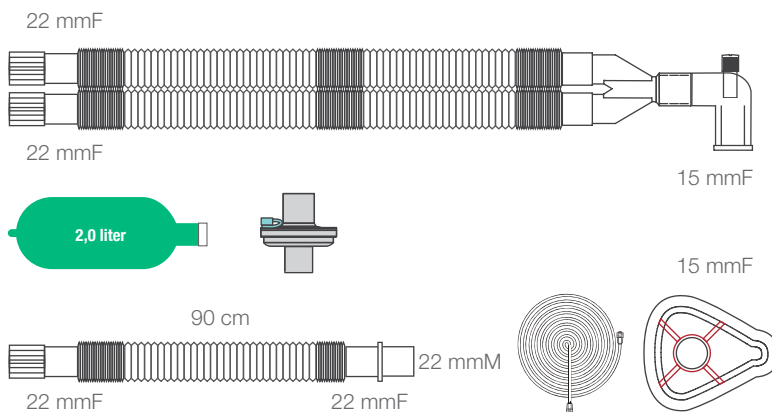

Corrugated

	Length	Code	Qty/Box
Adult	160 cm/63"	AL-1101-170/5	30
Pediatric	160 cm/63"	AL-1401-170/5	40
Neonatal	160 cm/63"	AL-1701-170/5	50

Extendible

	Length	Code	Qty/Box
Adult	180 cm/71"	AL-1303-170/5	40
Pediatric	150 cm/59"	AL-1603-170/5	40

Smoothbore

	Length	Code	Qty/Box
Adult	180 cm /71"	AL-1202-170/5	40
Pediatric	150 cm /59"	AL-1502-170/5	40
Neonatal	150 cm /59"	AL-1802-170/5	40

Complete and efficient anesthesia circuit pack



Low-Flow Anesthesia Parallel Circuit

- Effective and safe sidestream measurement of CO₂ during low-flow anesthesia
- Coextruded, double layer gas sampling line. Inner tube PE for accurate measurement / outer tube PVC to avoid kinking
- Precise sampling of CO₂
- Delivering an accurate and quantitative reading.

ANESTHESIA CIRCUIT WITH LIMB BREATHING BAG / BACTERIAL VIRAL FILTER / CO₂ SAMPLING LINE

Corrugated

	Length	Code	Qty/Box
Adult	160 cm/63"	AL-1121-160/5	30
Pediatric	160 cm/63"	AL-1421-160/5	50
Neonatal	160 cm/63"	AL-1721-160/5	50

Extendible

	Length	Code	Qty/Box
Adult	180 cm/71"	AL-1323-160/5	50
Pediatric	150 cm/59"	AL-1623-160/5	60

Smoothbore

	Length	Code	Qty/Box
Adult	180 cm/71"	AL-1222-160/5	30
Pediatric	150 cm/59"	AL-1522-160/5	50
Neonatal	150 cm/59"	AL-1822-160/5	50

Corrugated

	Length	Code	Qty/Box
Adult	160 cm/63"	AL-1121-160/6	50
Pediatric	160 cm/63"	AL-1421-160/6	50
Neonatal	160 cm/63"	AL-1721-160/6	50

Extendible

	Length	Code	Qty/Box
Adult	180 cm/71"	AL-1323-160/6	50
Pediatric	150 cm/59"	AL-1623-160/6	50

Smoothbore

	Length	Code	Qty/Box
Adult	180 cm /71"	AL-1222-160/6	40
Pediatric	150 cm /59"	AL-1522-160/6	40
Neonatal	150 cm /59"	AL-1822-160/6	40

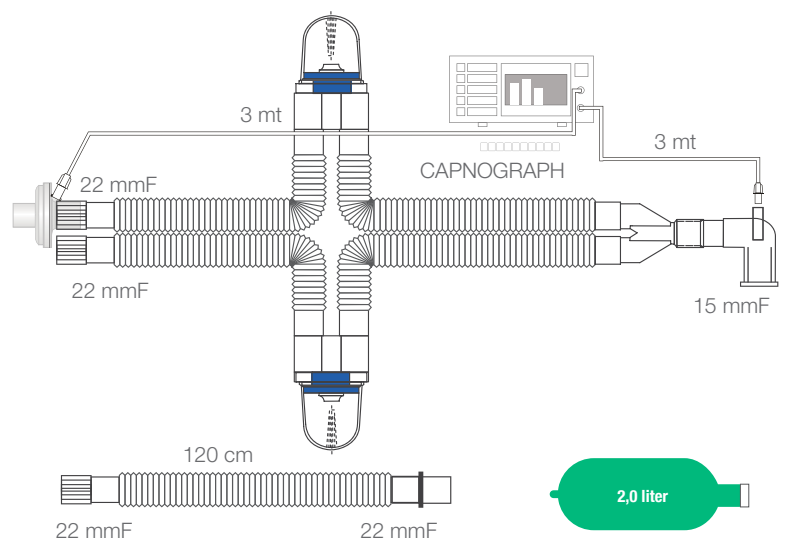
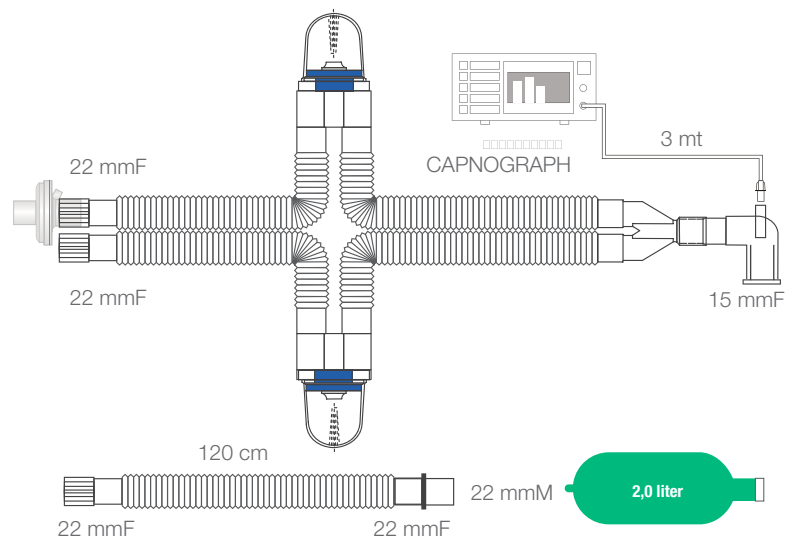

Coaxial Circuits

- Reliable, convenient and designed for enhancing natural warming of inspired gases, coaxial circuits with their streamlined tube-within-a-tube design eliminates the drag on the patient .
- The system provides increased circuit mobility and low weight in comparison with a traditional circle circuit.
- The best advantage of this coaxial design is to provide a self-contained, thermally efficient atmosphere where inspired gases are naturally warmed and humidified.
- All fittings comply with ISO 5356 standard.
- Although coaxial circuit has been designed as an anesthesia circle system, it has also proven to be suitable in the ICU as providing a desired level of humidity



MEDI-FLOW CIRCUIT

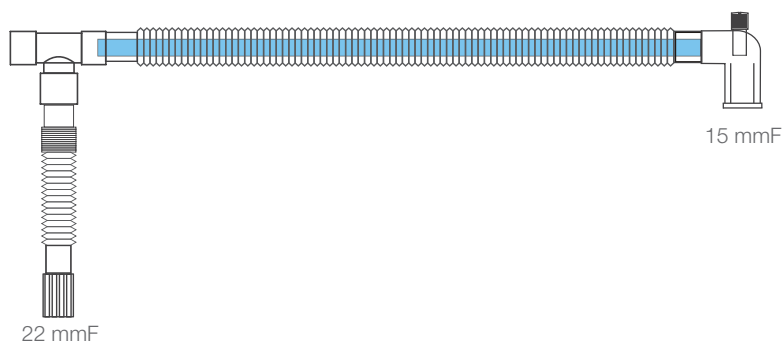

Corrugated			
	Length	Code	Qty/Box
Adult	180 cm/71"	AL-1900	40
Pediatric	150 cm/59"	AL-P1900	40

MEDI-FLOW CIRCUIT WITH LIMB & BREATHING BAG

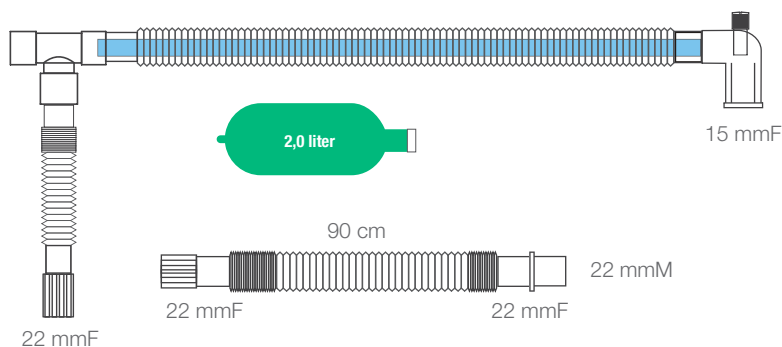

Corrugated			
	Length	Code	Qty/Box
Adult	180 cm/71"	AL-1903-060	30
Pediatric	150 cm/59"	AL-P1903-060	30

MEDI-FLOW CIRCUIT WITH LIMB BREATHING BAG / BACTERIAL FILTER/GAS SAMPLING LINE

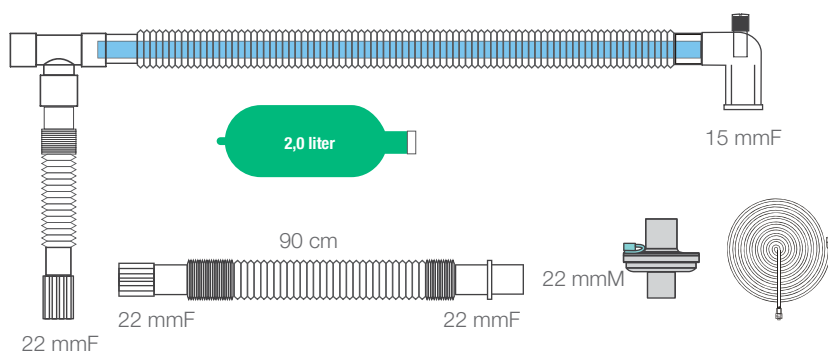

Corrugated			
	Length	Code	Qty/Box
Adult	180 cm/71"	AL-1903-160/5	30
Pediatric	150 cm/59"	AL-P1903-160/5	30



Coaxial Anesthesia Circuits with Water Trap

- Altech coaxial (tube-within-a-tube) breathing system ideal for use within both operating room and ICU. It is well suited to low flow anaesthesia.
- Water trap on this circuit with its unique design withdraws condensation from the circuit to secure the machine and contributes ventilation by preventing resistance to air which occurs due to water condensation.
- Water traps also eliminate the possible infection risk in ICU leading to sepsis caused by condensation accumulation within the inspiratory and expiratory lines.
- Optional CO2 monitoring line collects end tidal CO2 from the tip of the patient elbow connector. This provides accurate gas sampling.

COAXIAL CIRCUIT W/INTEGRATED WATER TRAP

Corrugated

	Length	Code	Qty/Box
Adult	180 cm/71"	AL-1913-060	30
Pediatric	150 cm/59"	AL-P1913-060	30

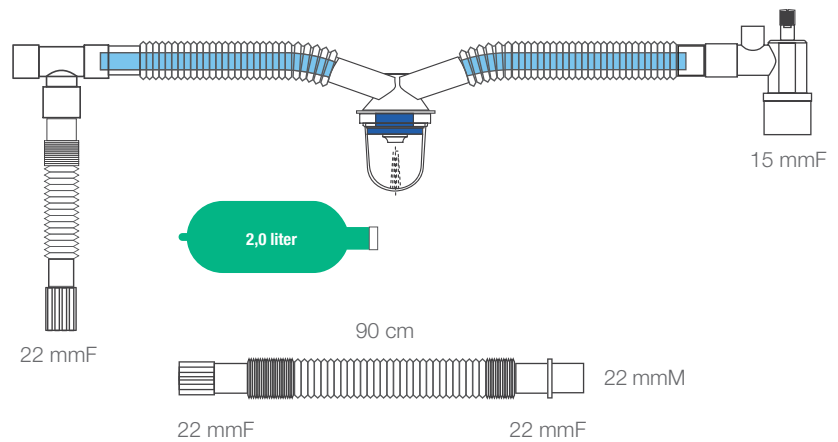

LOW - FLOW COAXIAL CIRCUIT W/INTEGRATED DOUBLE WATER TRAP

Corrugated

	Length	Code	Qty/Box
Adult	180 cm/71"	AL-1923-060	30
Pediatric	150 cm/59"	AL-P1923-060	30

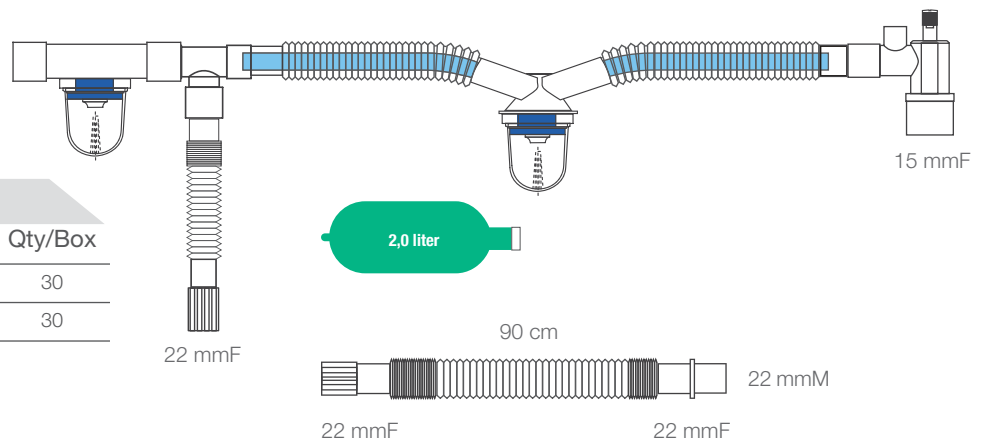

Semi-Closed Circuits

- Mapleson Circuits
- Modified Jackson Rees Circuits
- Bain Circuits
- Circuits with APL Valve



MAPLESON D-DELUXE BAIN CIRCUIT

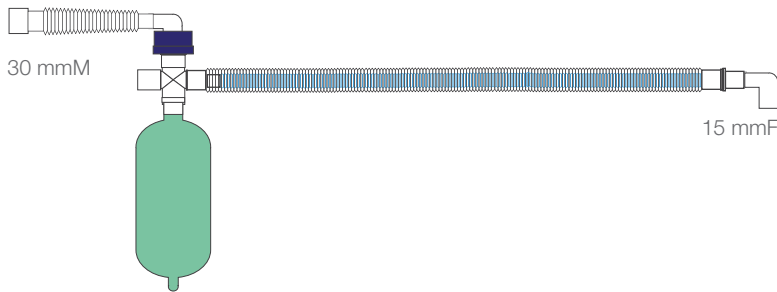

	Corrugated		
	Length	Code	Qty/Box
Adult	140 cm/55"	AL-0030	30

MAPLESON A CIRCUIT

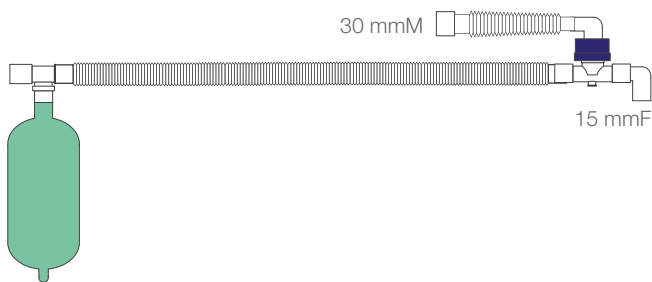

	Corrugated		
	Length	Code	Qty/Box
Adult	140 cm/55"	AL-0031	30

MAPLESON C CIRCUIT

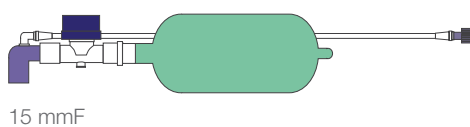

	Corrugated		
	Length	Code	Qty/Box
Adult	110 cm/43"	AL-0032	30

Semi-Closed Circuits

- Mapleson Circuits
- Modified Jackson Rees Circuits
- Bain Circuits
- Circuits with APL Valve



MODIFIED JACKSON REES FRESH GAS LINE,
NORMAN MASK ELBOW, TAIL BLEED VALVE
WITH BREATHING BAG

Corrugated

	Length	Code	Qty/Box
Adult	140 cm/55"	AL-0110-040/7	50
Pediatric	160 cm/63"	AL-0410-040/7	50

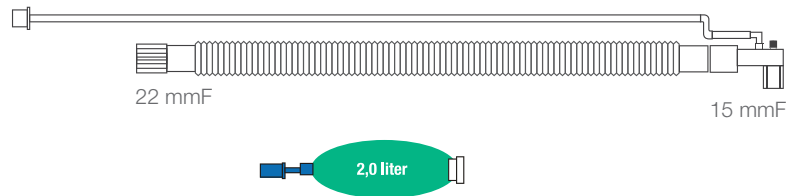

MAPLESON D CIRCUIT
WASHINGTON TEE, WITH BREATHING BAG

Corrugated

	Length	Code	Qty/Box
Adult	140 cm/55"	AL-0140-010/7	50
Pediatric	140 cm/55"	AL-0440-010/7	50

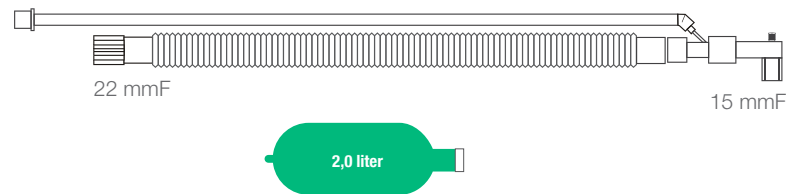

BAIN CIRCUITS STANDART
1/4" BARBED FRESH GAS CONNECTO,
WITH BREATHING BAG

Corrugated

	Length	Code	Qty/Box
Adult	140 cm/55"	AL-0150-010	50
Pediatric	160 cm/63"	AL-0450-010	50

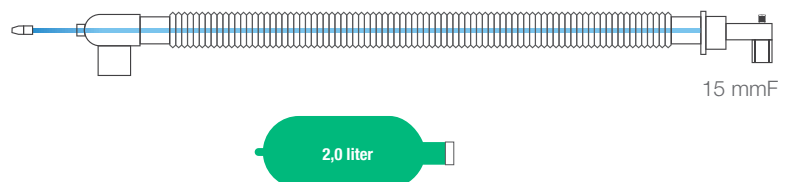

Ventilation Circuits

- Altech ventilation circuit range is specially designed with low compliance tubes for patients requiring mechanical ventilation in Intensive Care Units.
- A wide variety of ICU Breathing Systems are offered to meet individual requirements without compromising the patient and healthcare workers safety.



VENTILATION CIRCUITS WITH INSP. & EXP. WATER TRAP & BACTERIAL HME FILTER & CATHETER MOUNT & LIMB

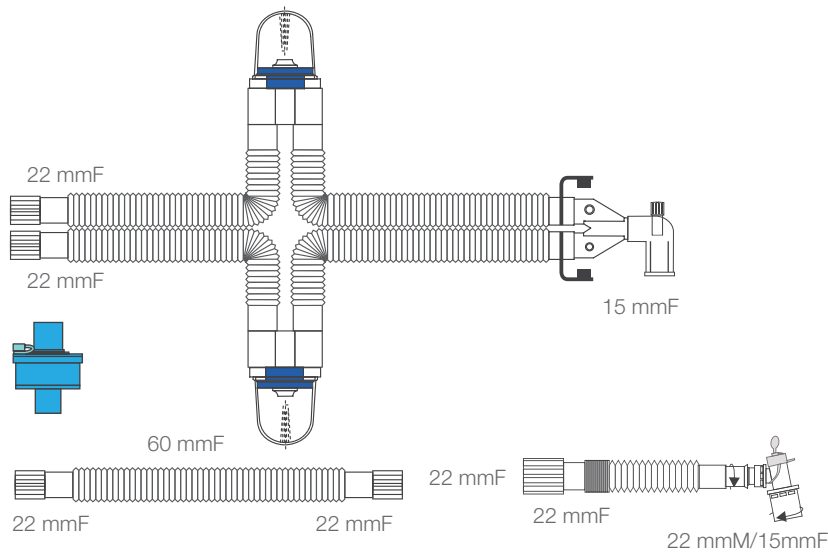

Corrugated

	Length	Code	Qty/Box
Adult	160 cm/63"	AL-1121-206	30
Pediatric	160 cm/63"	AL-1421-206	30

Extendible

	Length	Code	Qty/Box
Adult	180 cm/71"	AL-1323-206	40
Pediatric	150 cm/59"	AL-1623-206	40

Smoothbore

	Length	Code	Qty/Box
Adult	180 cm/71"	AL-1222-206	30
Pediatric	150 cm/59"	AL-1522-206	30

VENTILATION CIRCUITS WITH LIMB&MDI CHAMBER

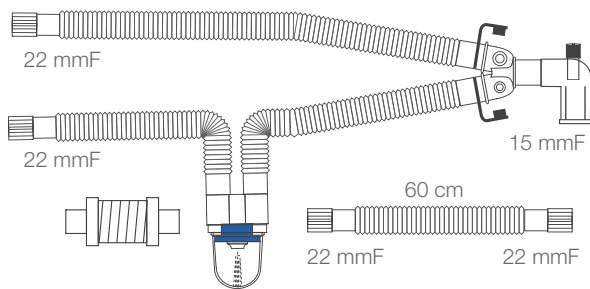

Corrugated

	Length	Code	Qty/Box
Adult	160 cm/63"	AL-1111-000/3	30
Pediatric	160 cm/63"	AL-1411-000/3	30

Smoothbore

	Length	Code	Qty/Box
Adult	160 cm/63"	AL-1212-000/3	30
Pediatric	160 cm/63"	AL-1512-000/3	30

VENTILATION CIRCUITS WITH LIMB & MDI CHAMBER

- A special circuit for delivering aerosoled bronchodilators through ventilator circuit thanks to a specially designed collapsible holding chamber to be left in the inspiratory limb of a ventilator circuit, and can be collapsed when not in use without interruption of continuous mechanical ventilation.

- Improved Medication Delivery
- 22M/22F connections
- Can be used with all commonly prescribed MDI canisters



MDI Chamber

	Code	Qty/Box
Adult	AL-0001	50



Fully Closed Ventilation Circuits

CONTINUITY OF MECHANICAL VENTILATION and MINIMUM INFECTION RISK
 Proper humidification of mechanically ventilated patients is very important. Active humidification commonly used for adequate humidification comes with challenge of water condensation in the circuit. Condensation that collects in the ventilation circuit is considered to be contaminated and it should be handled and removed carefully for infection control purposes. If the system is opened to drain the condensate; consequences such as contamination of interior of the circuit; exposure of caregiver to contaminated condensate; cross-contamination of other patients and possible collapse of the alveoli due to breakage of the circuit increase the risk of interruption and failure of clinicians' therapy. Collection and drainage of the condensate with a closed system is crucial to eliminate challenges above and to prevent infection (VAP and sepsis). Altera fully closed ventilation circuits contribute to continuous ventilation therapy without interruption and with minimized infection risk.

COAXIAL VENTILATION CIRCUIT W/INTEGRATED NEEDLE FREE WATER TRAP

Corrugated			
	Length	Code	Qty/Box
Adult	180 cm/71"	AL-1923-000/9.V002	50
Pediatric	180 cm/71"	AL-P1923-000/9.V002	50

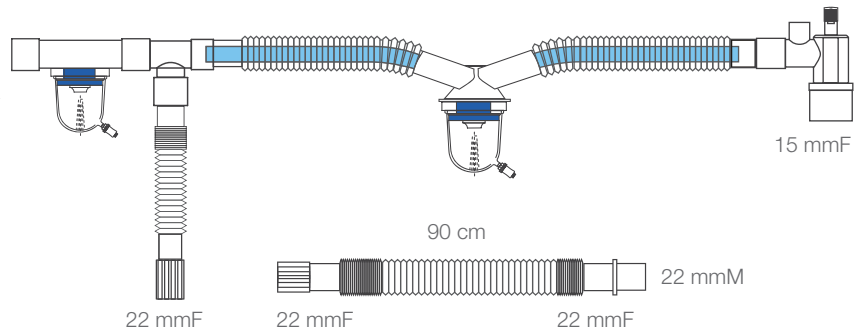

COAXIAL VENTILATION CIRCUIT W/INTEGRATED NEEDLE FREE WATER TRAP

Corrugated			
	Length	Code	Qty/Box
Adult	180 cm/71"	AL-1923-000/9.V001	50
Pediatric	180 cm/71"	AL-P1923-000/9.V001	50

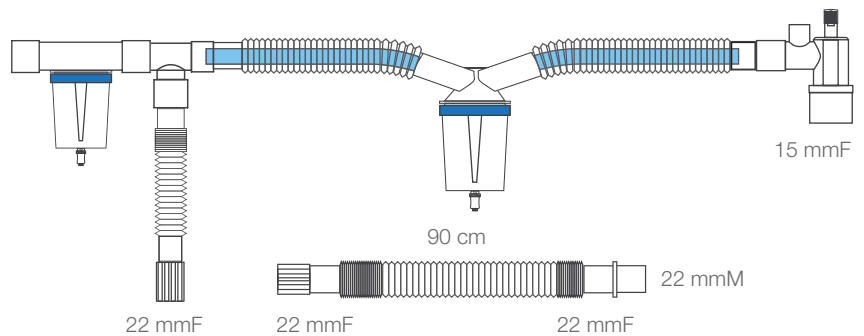

PARALLEL VENTILATION CIRCUIT W/INTEGRATED NEEDLE FREE WATER TRAP

Corrugated			
	Length	Code	Qty/Box
Adult	160 cm/63"	AL-1111-000/9.V001	50
Pediatric	160 cm/63"	AL-1411-000/9.V001	50

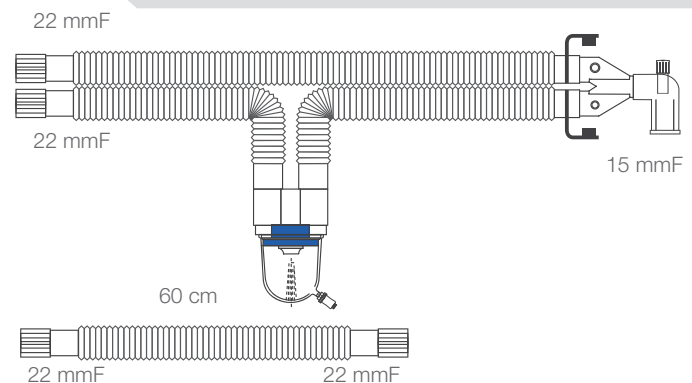

Ventilation Circuits

Safety

- Offering a wide range of water traps
- The self-sealing closure allows the water trap to be emptied without interrupting flow.
- As the base of water trap is opened the internal valve automatically shuts down and
- Avoids possible air leakages

VENTILATION CIRCUIT W/WATER TRAP LIMB & BACTERIAL HME FILTER & CATHETER MOUNT

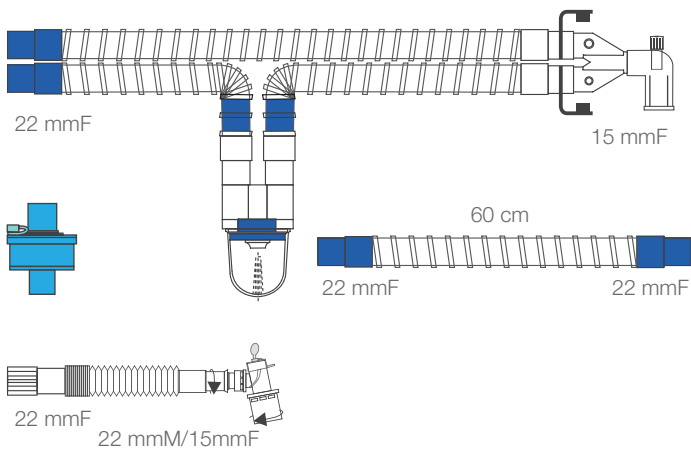

Corrugated

	Length	Code	Qty/Box
Adult	160 cm/63"	AL-1111-206	25
Pediatric	160 cm/63"	AL-1411-206	25

Smoothbore

	Length	Code	Qty/Box
Adult	180 cm/71"	AL-1212-206	30
Pediatric	150 cm/59"	AL-1512-206	30

Extendible

	Length	Code	Qty/Box
Adult	180 cm/71"	AL-1313 -206	40
Pediatric	150 cm/59"	AL-1613-206	40

VENTILATION CIRCUIT W/WATER TRAPS LIMB & BACTERIAL HME FILTER & CATHETER MOUNT

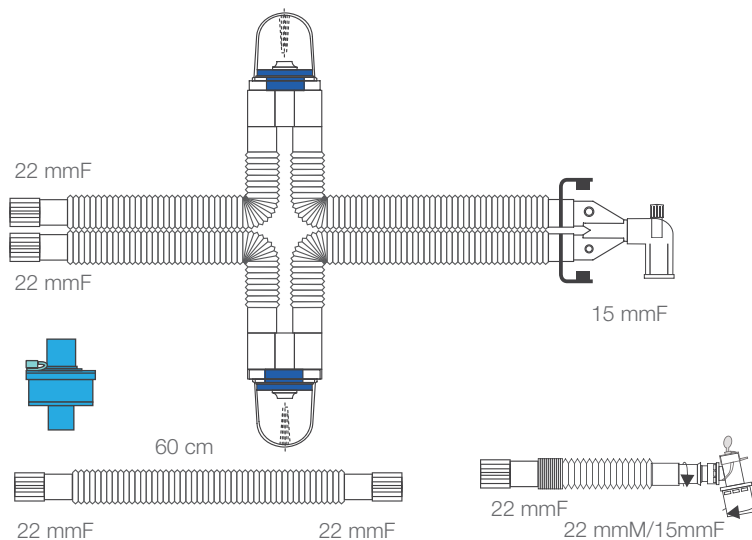

Corrugated

	Length	Code	Qty/Box
Adult	160 cm/63"	AL-1121-206	30
Pediatric	160 cm/63"	AL-1421-206	40

Smoothbore

	Length	Code	Qty/Box
Adult	180 cm/71"	AL-1222-206	30
Pediatric	150 cm/59"	AL-1522-206	40

Extendible

	Length	Code	Qty/Box
Adult	180 cm/71"	AL-1323-206	40
Pediatric	150 cm/59"	AL-1623-206	50

IPPB Circuits

- We offer a range of disposable adult IPPB breathing systems for use with the majority of transport ventilators to be used with inter hospital patient transfer.
- For use with all IPPB machines.
- Mouth piece, cateter mount, nebulizer or other accessories may be adapted while assembling.
- Exhalation valve with clear cap and expiratory flow diverter.



IPPB CIRCUITS

Corrugated

	Length	Code	Qty/Box
Adult	160 cm/63"	AL-3110-026	40

Smoothbore

	Length	Code	Qty/Box
Adult	160 cm/63"	AL-3210-026	40

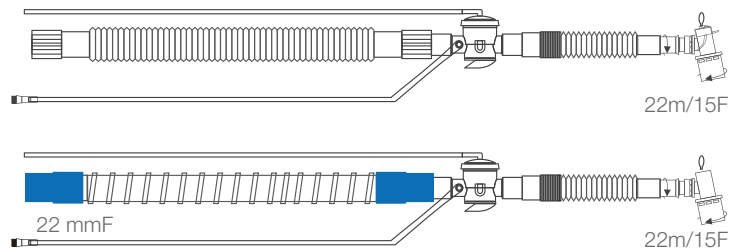

IPPB CIRCUITS WITH NEBULISER

Corrugated

	Length	Code	Qty/Box
Adult	160 cm/63"	AL-3110-026/4	30

Smoothbore

	Length	Code	Qty/Box
Adult	160 cm/63"	AL-3210-026/4	30

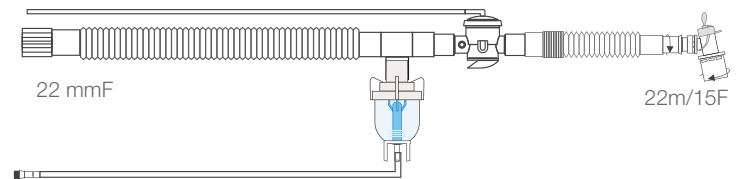

IPPB CIRCUITS

Corrugated

	Length	Code	Qty/Box
Adult	160 cm/63"	AL-3120-026	50

Smoothbore

	Length	Code	Qty/Box
Adult	160 cm/63"	AL-3220-026	50

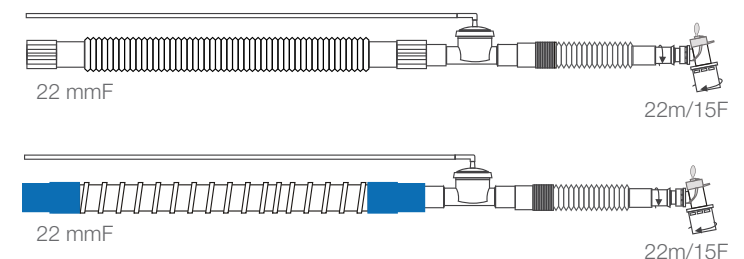

Heated Wire Circuits

- Compatible with MR500,600,730, Coancha 4 Vital Signs SCT3000
- Compatible with MR850 inspiratory, limb
- Compatible with MR850 expiratory, limb



HEATED WIRE CIRCUITS, SINGLE HEATED WIRE WITH LIMB FOR MR800 SERIES HUMIDIFIER

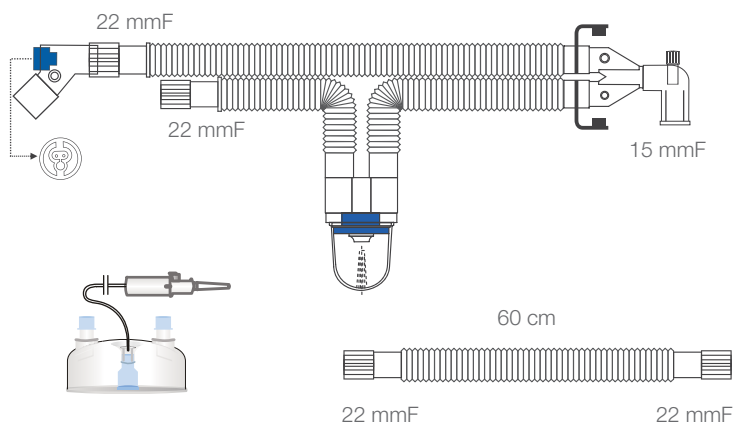

Corrugated

	Length	Code	Qty/Box
Adult	180 cm/71"	AL-4111-020/2	30
Pediatric	180 cm/71"	AL-4411-020/2	30

Smoothbore

	Length	Code	Qty/Box
Adult	180 cm/71"	AL-4212-020/2	30
Pediatric	180 cm/71"	AL-4512-020/2	30

HEATED WIRE CIRCUITS, SINGLE HEATED WIRE WITH LIMB FOR MR700 SERIES HUMIDIFIER

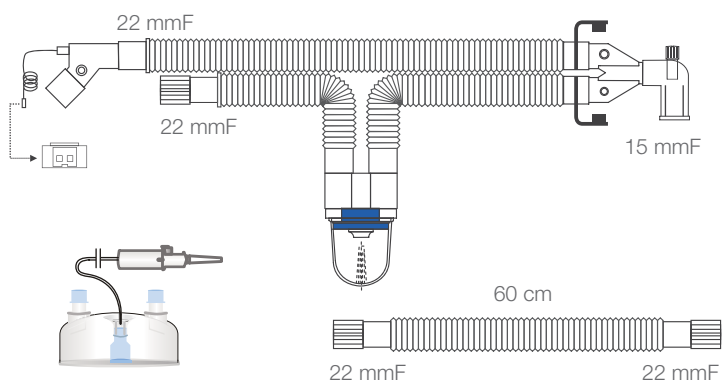

Corrugated

	Length	Code	Qty/Box
Adult	180 cm/71"	AL-4111-010/2	30
Pediatric	180 cm/71"	AL-4411-010/2	30

Smoothbore

	Length	Code	Qty/Box
Adult	180 cm/71"	AL-4212-010/2	30
Pediatric	180 cm/71"	AL-4512-010/2	30

Heated Wire Circuits

- Compatible with MR500,600,730, Coancha 4 Vital Signs SCT3000
- Compatible with MR850 inspiratory, limb
- Compatible with MR850 expiratory, limb



HEATED WIRE CIRCUITS, DOUBLE HEATED WIRE WITH LIMB FOR MR800 SERIES HUMIDIFIER

Corrugated

	Length	Code	Qty/Box
Adult	180 cm/71"	AL-5101-020/2	30
Pediatric	180 cm/71"	AL-5401-020/2	30

Smoothbore

	Length	Code	Qty/Box
Adult	180 cm/71"	AL-5202-020/2	30
Pediatric	180 cm/71"	AL-5502-020/2	30

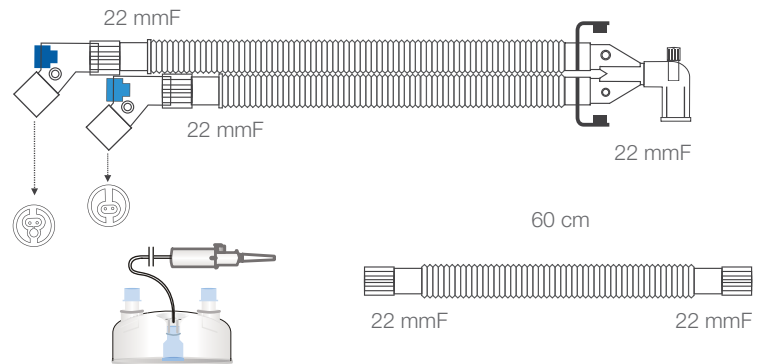

HEATED WIRE CIRCUITS, DOUBLE HEATED WIRE WITH LIMB FOR MR800 SERIES HUMIDIFIER

Corrugated

	Length	Code	Qty/Box
Adult	180 cm/71"	AL-5121-020/2	30
Pediatric	180 cm/71"	AL-5421-020/2	30

Smoothbore

	Length	Code	Qty/Box
Adult	180 cm/71"	AL-5222-020/2	30
Pediatric	180 cm/71"	AL-5522-020/2	30

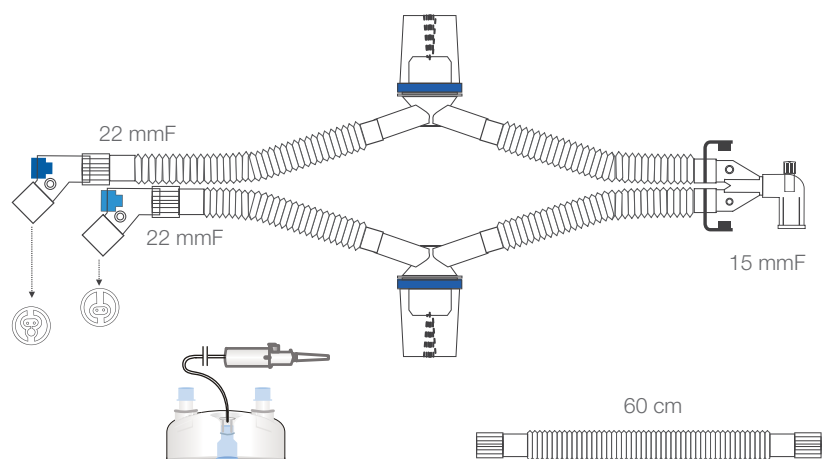

Embedded Heated Wire Circuits

- Uniform heating along the length of the tube
- Very effective in avoiding condensation
- No substrate for bacterial VAP
- Wires have no direct contact with air flow
- Minimizing condensate related ventilator alarms
- Extremely low compliance and flow resistance due to smooth interior tube



EMBEDDED ADULT HEATED WIRE CIRCUIT WITH AUTOFEED HUMIDIFIER CHAMBER

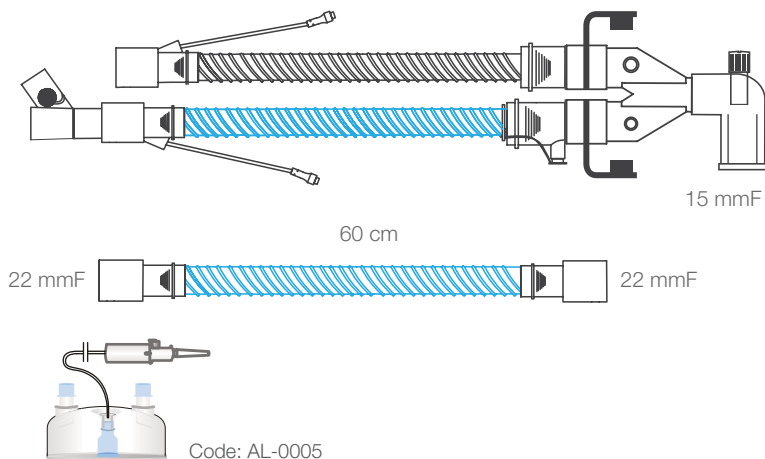

Smoothbore			
	Length	Code	Qty/Box
Adult	180 cm/71"	AL-52602-020/2	25

EMBEDDED PEDIATRIC HEATED WIRE CIRCUIT WITH AUTOFEED HUMIDIFIER CHAMBER

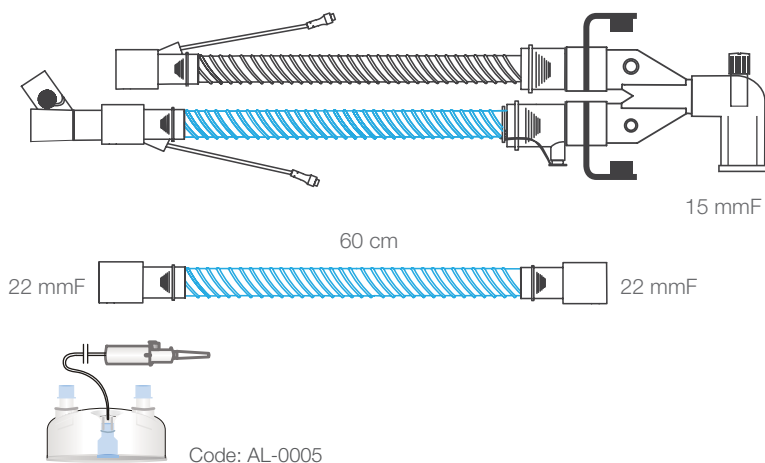

Smoothbore			
	Length	Code	Qty/Box
Pediatric	180 cm/71"	AL-52702-020/2	25

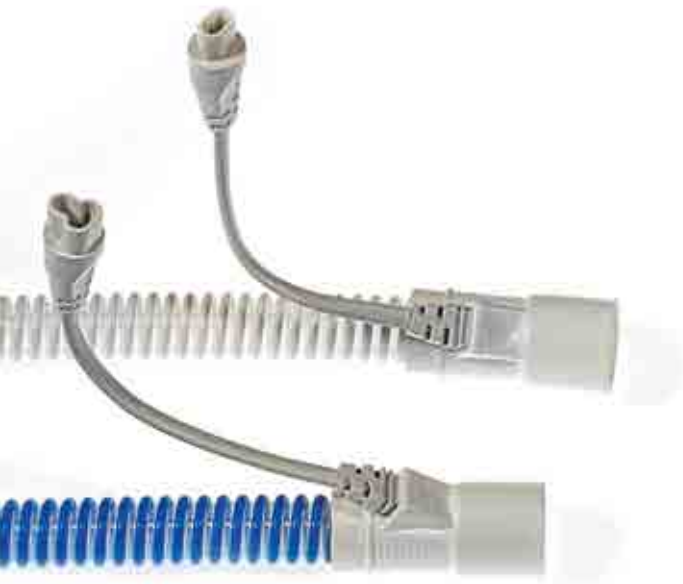

Embedded Heated Wire Circuits

- Uniform heating along the length of the tube
- Very effective in avoiding condensation
- No substrate for bacterial VAP
- Wires have no direct contact with air flow
- Minimizing condensate related ventilator alarms
- Extremely low compliance and flow resistance due to smooth interior tube

EMBEDDED NEONATAL HEATED WIRE CIRCUIT WITH AUTOFEED HUMIDIFIER CHAMBER

Smoothbore			
	Length	Code	Qty/Box
Neonatal	180 cm/71"	AL-52802-020/2	25

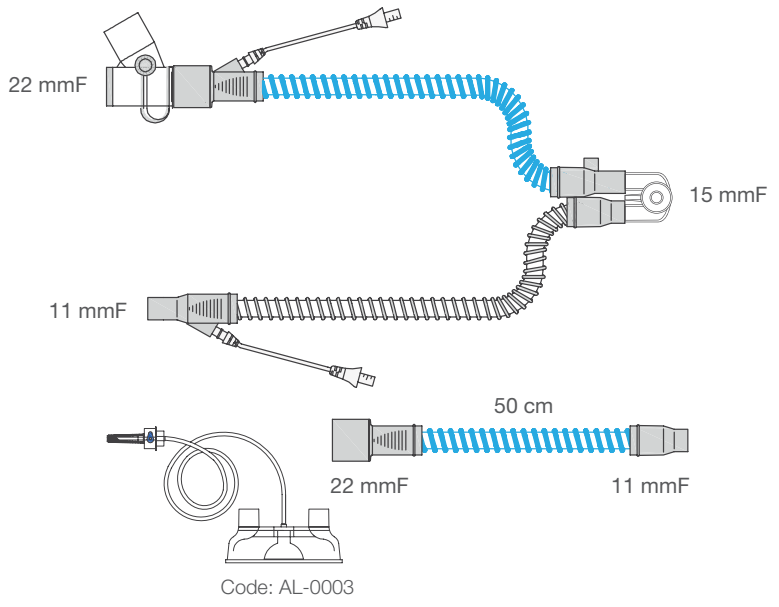

EMBEDDED NEONATAL HEATED WIRE CIRCUIT WITH AUTOFEED HUMIDIFIER CHAMBER

Smoothbore			
	Length	Code	Qty/Box
Neonatal	180 cm/71"	AL-52902-020/2	25

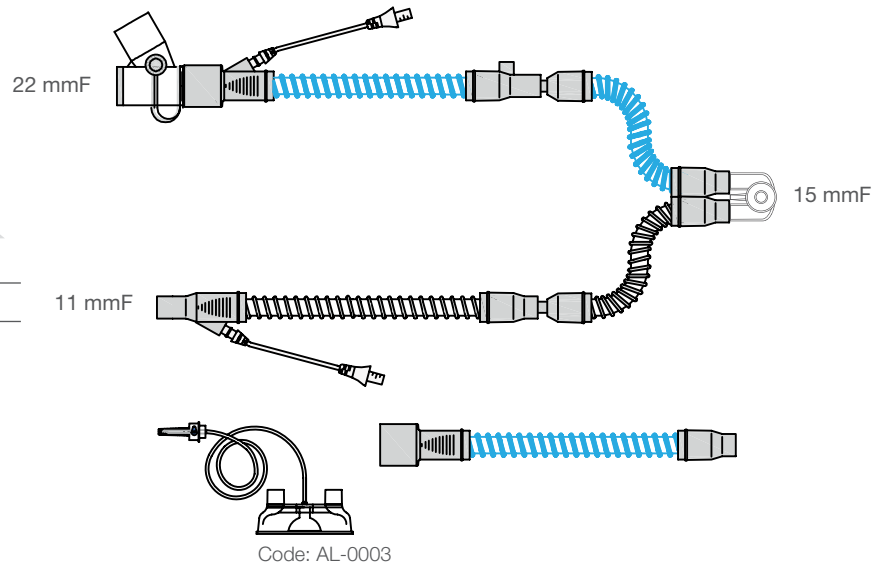

Neonatal Circuits

- Altech has designed a range of neonatal circuits for use in the NICU , Operating Rooms providing safe and effective solutions for neonatal respiratory
- Y connector with rounded design avoids risk of rebreathing and ensures a very low dead space.



SINGLE HEATED WIRE NEONATAL CIRCUITS PROXIMAL LINE & LIMB & AUTOFEED CHAMBER

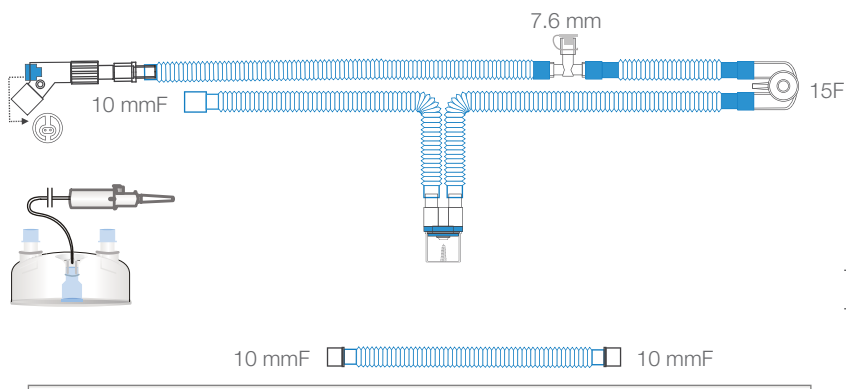

Corrugated		
Length	Code	Qty/Box
180 cm/71"	AL-4711-020/2	50

ADAPTOR SET

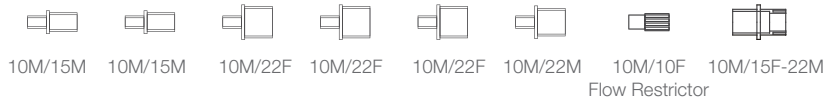

SINGLE HEATED WIRE NEONATAL CIRCUITS PROXIMAL LINE & LIMB & AUTOFEED CHAMBER

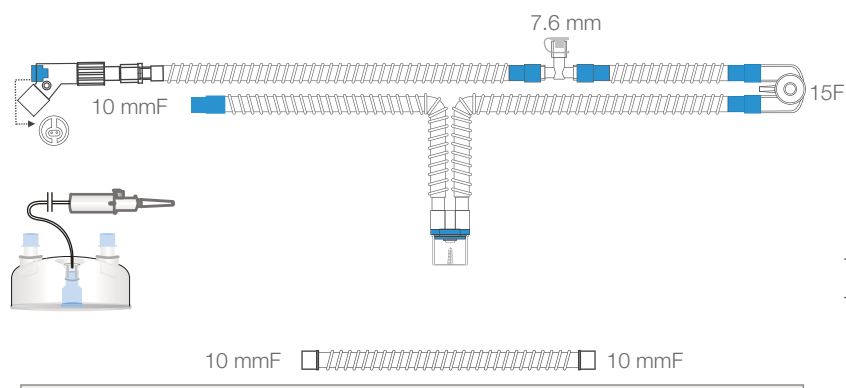

Smoothbore		
Length	Code	Qty/Box
180 cm/71"	AL-4812-020/2	50



CPAP Circuits

CPAP (Continuous Positive Airway Pressure)

- CPAP is the method of ventilating a patient applying a higher pressure than environmental atmospheric pressure to the airways of the patient to improve oxygenation via ventilator or a CPAP machine.
- CPAP prevents early end-expiratory closure of the airways and alveolar collapse.
- Today CPAP is routinely used for mechanically ventilated patients or spontaneously breathing respiratory patients to improve the oxygenisation.
- Today CPAP therapy is the first choice in the treatment and prevention of postoperative atelectasis, early stages of ARDS and obstructive sleep apnea.



CPAP CIRCUIT FOR NON-INVASIVE VENTILATION

Corrugated

	Length	Code	Qty/Box
Adult	160 cm/63"	AL-7100-011	30

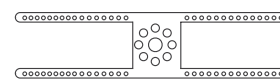
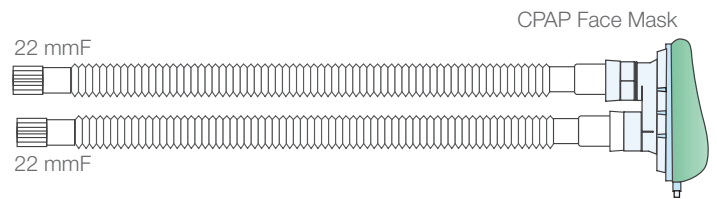

Headstrap

Code: 150.11.010

CPAP CIRCUIT FOR FLOW GENERATORS

Corrugated

	Length	Code	Qty/Box
Adult	160 cm/63"	AL-6120-011	30

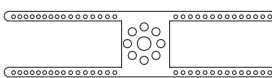
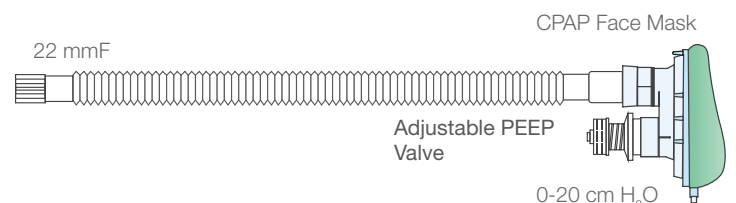

Headstrap

Code: 150.11.010

BPAP Circuits

- (BPAP) Bilevel Positive Airway Pressure Bilevel positive airway pressure (BPAP) is a modified version of the continuous positive airway pressure (CPAP). It is a mode of ventilation with cycling variations between two continuous positive airway pressure levels. This mode offers two different levels of air pressure: increased pressure during inhalation and decreased pressure during exhalation.



BPAP CIRCUITS, FULL FACE MASK



Corrugated			
	Length	Code	Qty/Box
Adult	180 cm/71"	AL-8190-014	40

Smoothbore			
	Length	Code	Qty/Box
Adult	180 cm/71"	AL-8290-014	40

BPAP CIRCUITS, NASAL MASK WITH EXHAUST CONNECTOR

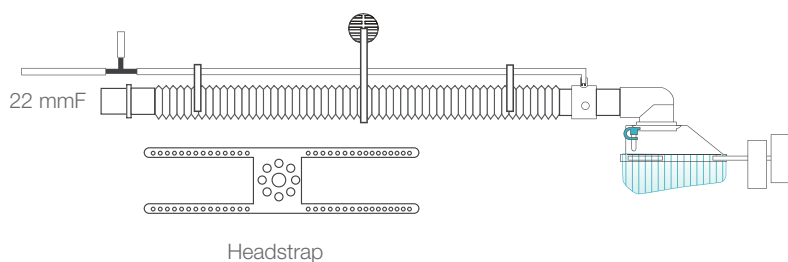

Corrugated			
	Length	Code	Qty/Box
Adult	180 cm/71"	AL-8190-014/9	30

Smoothbore			
	Length	Code	Qty/Box
Adult	180 cm/71"	AL-8290-014/9	30

BPAP Circuits

- BPAPs may work better for those individuals who cannot comfortably breathe out against the fixed pressure of the standard device. Therefore BPAP is used for patients with restrictive or obstructive disorders, and for patients with sleep apnea who cannot tolerate the high pressure of CPAP.



BPAP CIRCUITS

Smoothbore

	Length	Code	Qty/Box
Adult	180 cm/71"	AL-8290-005/7	50

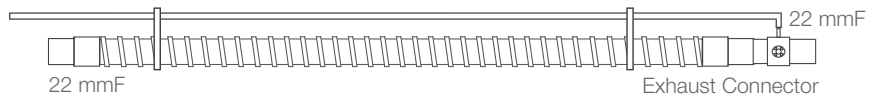

Breathing system for use with Respirationics BiPAP®VISION AND S/T-D

BPAP CIRCUITS

Smoothbore

	Length	Code	Qty/Box
Adult	180 cm/71"	AL-8290-105/9	40

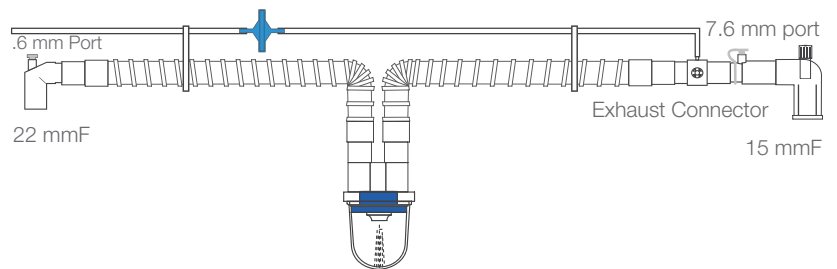

Breathing system for use with Respirationics BiPAP®VISION AND S/T-D

Home Care Circuits



HOME CARE CIRCUITS WITH WATER TRAP, TEMPERATURE ADAPTOR

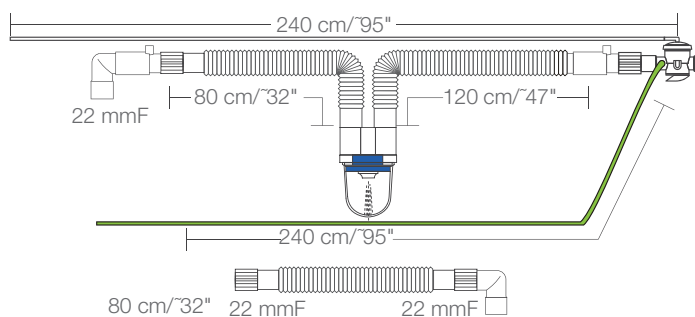

Corrugated			
	Length	Code	Qty/Box
Adult	200 cm/79"	AL-3111-040	30

Breathing system for use with Legend Air

HOME CARE CIRCUITS

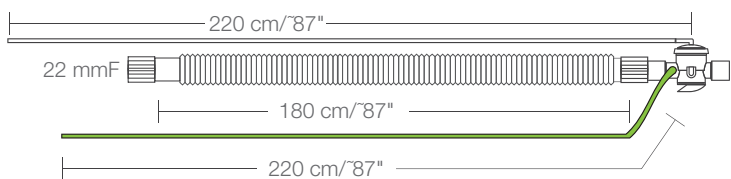

Corrugated			
	Length	Code	Qty/Box
Adult	180 cm/71"	AL-3110	40

Breathing system for use with Legend Air

HOME CARE CIRCUITS

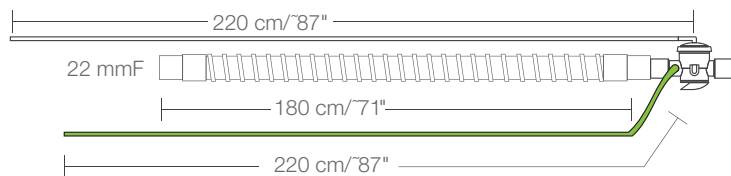

Smoothbore			
	Length	Code	Qty/Box
Adult	180 cm/71"	AL-3210	50

Breathing system for use with Legend Air and Saime Ultra V/S

Ø ID: 4.80
 Ø ID: 4.00

Home Care Circuits



HOME CARE CIRCUITS WITH WATER TRAP

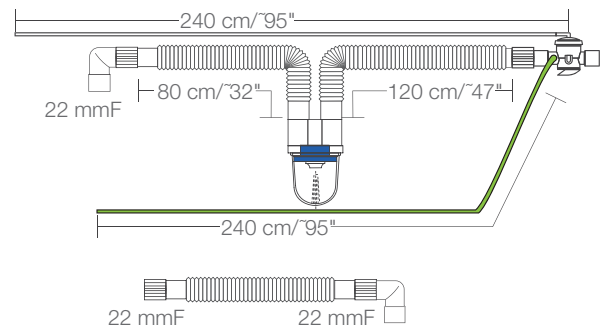

Corrugated

	Length	Code	Qty/Box
Adult	200 cm/79"	AL-3111-050	30

Breathing system for use with Saima Ultra V/S200 cm/79"

HOME CARE CIRCUITS WITH WATER TRAP, TEMPERATURE ADAPTOR

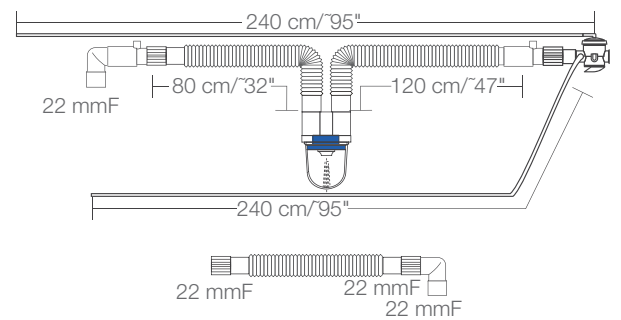

Corrugated

	Length	Code	Qty/Box
Adult	200 cm/79"	AL-3111-040	30

Breathing system for use with ELISE150

HOME CARE CIRCUITS

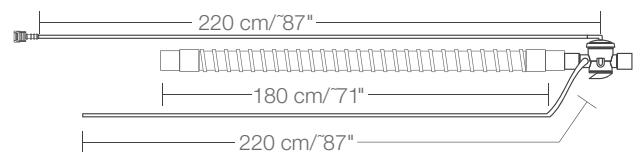

Smoothbore

	Length	Code	Qty/Box
Adult	180 cm/71"	AL-3210	50

 Ø ID: 4.00
 Ø ID: 4.80



altech[®]

a Meditera Company

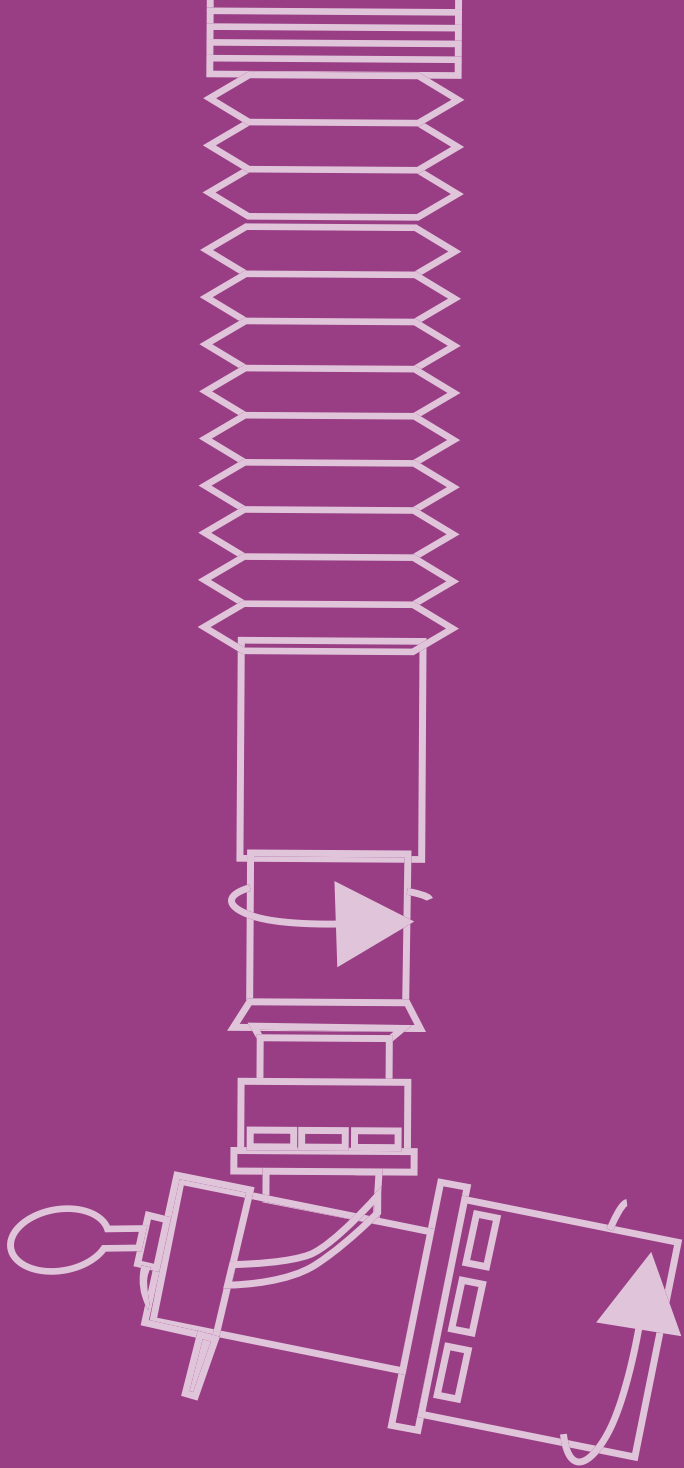

Catheter Mounts

Catheter Mounts

Altech range of catheter mounts includes a wide choice of smoothbore PVC and extendible configurations

- Smoothbore products provide low resistance to flow while external coil reduces kinks and blockages. Besides they prevent fluid build up reducing risks of bacterial growth thanks to smooth inner surface.
- Extendible PP product provides a lightweight and flexible solution and allows clinician to adjust the position of the catheter mount
- 360 degree double swivel connector increases ease of use
- Double cap helps to maintain PEEP during suctioning or bronchoscopy.
- Luer lock port for gas sampling
- 15M or 22F adapters available



CATHETER MOUNT EXTENDIBLE

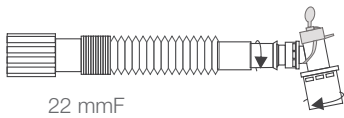

22 mmF

Dead space (ml): Close: 25, Open: 40

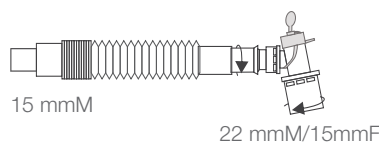

15 mmM

22 mmM/15mmF

Dead space (ml): Close: 25, Open: 40

Extendible

Length	Code	Qty/Box
15 cm/6"	AL-17300	50
15 cm/6"	AL-13300	50

CATHETER MOUNT SMOOTH BORE

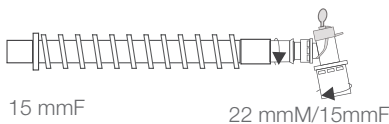

15 mmF

Dead space (ml): 30

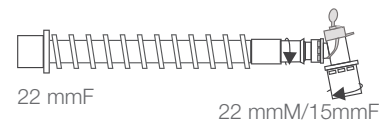

22 mmF

22 mmM/15mmF

Dead space (ml): 30

Smoothbore

Length	Code	Qty/Box
15 cm/6"	AL-12300	50
15 cm/6" (PVC-free)	AL-P12300	50

Smoothbore

Length	Code	Qty/Box
15 cm/6"	AL-16300	50
15 cm/6" (PVC-free)	AL-P16300	50

CATHETER MOUNT & FILTER

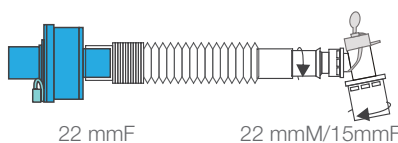

22 mmF

22 mmM/15mmF

Dead space (ml): Close: 103, Open: 117

Extendible

Length	Code	Qty/Box
15 cm/6"	AL-17380	20

Catheter Mounts



CATHETER MOUNTS

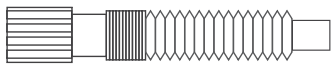

22 mmF 15 mmM/22 mmF

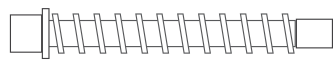

22 mmF 15 mmM/22 mmF

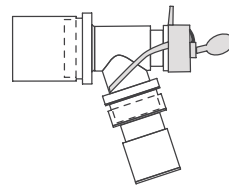

EXTENDIBLE TUBE

CODE: 67300
QTY/Box: 50
Dead space (ml):
Close: 22, Open: 37

SMOOTH BORE TUBE

CODE: 66300
PVC-FREE CODE: P66300
QTY/Box: 50
Dead space (ml): 27

SWIVEL CATHETER MOUNT

CODE: AL-10000
QTY/Box: 100
Dead space (ml): 3

CATHETER MOUNT SMOOTH BORE

Smoothbore

Length	Code	Qty/Box
15 cm/6"	AL-22300	50
15 cm/6" (PVC-free)	AL-P22300	50

Smoothbore

Length	Code	Qty/Box
15 cm/6"	AL-26300	50
15 cm/6" (PVC-free)	AL-P26300	50



22 mmF 22 mmM/15 mmF 22 mmF 22 mmM/15 mmF

Dead space (ml): 30

CATHETER MOUNT EXTENDIBLE

Extendible

Length	Code	Qty/Box
15 cm/6"	AL-27300	50

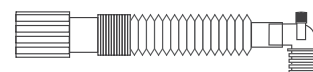

22 mmF 22 mmM/15 mmF

Dead space (ml): Close: 25, Open: 40



altech[®]

a Meditera Company



Filters

Bacterial Viral Filters

- Dedicated to the quality, committed to enhancing patient care Altera provides you with simple, cost effective, secure solutions and the best filtration efficiency for your respiratory patient.
- To help you minimize filtration challenges, we offer a comprehensive line of high-performance breathing filters.
- Each Altech branded filter provides its own unique advantages to maximize the clinical outcomes for filtration when used with multiple ventilator applications, such as noninvasive, invasive or anesthesia procedures.
- Our filters may help reduce the risk of possible hospital- or ventilator-acquired patient infections and may help create a safer environment for the caregiver by minimizing bacterial and viral particle penetration.



BACTERIAL VIRAL FILTERS

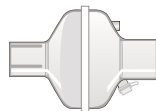

BACTERIAL-VIRAL FILTER

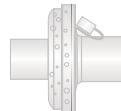

BACTERIAL-VIRAL FILTER

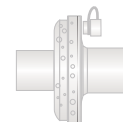

BACTERIAL-VIRAL FILTER

	SBC raw material	SBC raw material	PP raw material
Code	AL-08002	AL-08018	AL-08023
Sterile Code	AL-080029	AL-080189	AL-080239
Qty/Box	50	50	50
Tidal volume (ml)	150-1500	150-1500	150-1500
Dead Space (ml)	77	33	33
Bacterial Efficiency	>99,9999%	>99,9999%	>99,9999%
Viral Efficiency	>99,999%	>99,999%	>99,999%
Resistance to Flow	30 L/min 4,1 mm H ₂ O	30 L/min 4,3 mm H ₂ O	30 L/min 5 mm H ₂ O
	60 L/min 11,6 mm H ₂ O	60 L/min 12 mm H ₂ O	60 L/min 14 mm H ₂ O
	90 L/min 24,6 mm H ₂ O	90 L/min 25 mm H ₂ O	90 L/min 27,6 mm H ₂ O
Weight (gr)	23	19	21
Fittings	22mmM-15/22mmMF	22mmM - 15/22mmMF	22mmM - 15/22mmMF

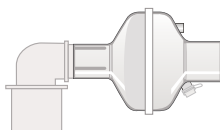

BACTERIAL-VIRAL FILTER
Angled

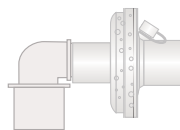

BACTERIAL-VIRAL FILTER
Angled

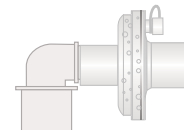

BACTERIAL-VIRAL FILTER
Angled

	SBC raw material	SBC raw material	PP raw material
Code	AL-08002/1	AL-08018/1	AL-08023/1
Sterile Code	AL-080029/1	AL-080189/1	AL-080239/1
Qty/Box	45	45	45
Tidal volume (ml)	150-1500	150-1500	150-1500
Dead Space (ml)	80	36	36
Bacterial Efficiency	>99,9999%	>99,9999%	>99,9999%
Viral Efficiency	>99,999%	>99,999%	>99,999%
Resistance to Flow	30 L/min 4,5 mm H ₂ O	30 L/min 4,5 mm H ₂ O	30 L/min 5,5 mm H ₂ O
	60 L/min 12 mm H ₂ O	60 L/min 12,5 mm H ₂ O	60 L/min 14,5 mm H ₂ O
	90 L/min 25 mm H ₂ O	90 L/min 25,5 mm H ₂ O	90 L/min 28 mm H ₂ O
Weight (gr)	28,5	24,5	26,5
Fittings	22mmM-15/22mmMF	22 mmM - 15/22 mmMF	22 mmM - 15/22 mmMF

Bacterial Viral HME Filters



- Bacterial Efficiency %99.9999
- High level of moisture output
- Small and paediatric versions
- Coupled with a hydrophobic bacterial viral filter membrane
- Rounded ergonomic housing
- Sterile or Clean
- Standart Retainable Monitoring Cap
- High level of moisture output(>33mgH₂O/L)
- Hygroscopic cellulose or foam HME Media
- ISO Standart Connectors
- Individually Packed

BACTERIAL VIRAL HME FILTERS

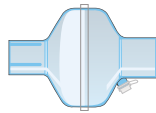

BACTERIAL-VIRAL/HME Filter

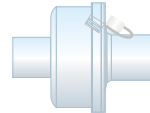

BACTERIAL-VIRAL/HME Filter with paper HME

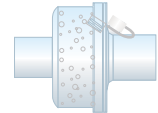

BACTERIAL-VIRAL/HME Filter with foam HME

	SBC raw material	SBC raw material	SBC raw material
Code	AL-08006	AL-08016	AL-08020
Sterile Code	AL-080069	AL-080169	AL-080209
Qty/Box	50	50	50
Tidal volume (ml)	150-1500	150-1500	150-1500
Dead Space (ml)	77	53	53
Bacterial Efficiency	>99,9999%	>99,9999%	>99,9999%
Viral Efficiency	>99,999%	>99,999%	>99,999%
Resistance to Flow	30 L/min 8,4 mm H ₂ O 60 L/min 19,9 mm H ₂ O 90 L/min 38,2 mm H ₂ O	30 L/min 9,4 mm H ₂ O 60 L/min 23,2 mm H ₂ O 90 L/min 42 mm H ₂ O	30 L/min 6 mm/H ₂ O 60 L/min 16,5 mm/H ₂ O 90 L/min 32 mm/H ₂ O
Weight (gr)	24	30	24
Fittings	22 mmM-15/22 mmMF	22 mmM -15/22 mmMF	22 mmM -15/22 mmMF
Humidification efficiency	38,6mgH ₂ O/L (@500 ml tid. vol.)	36,8 mgH ₂ O/L (@500 ml tid. vol.)	37,5 mgH ₂ O/L (@500 ml tid. vol.)

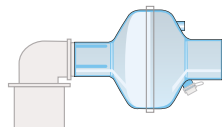

BACTERIAL-VIRAL/HME Filter Angled

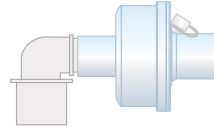

BACTERIAL-VIRAL/HME Filter Angled

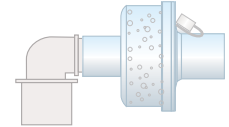

BACTERIAL-VIRAL/HME Filter Angled

	SBC raw material	SBC raw material	PP raw material
Code	AL-08006/1	AL-08016/1	AL-08020/1
Sterile Code	AL-080069/1	AL-080169/1	AL-080209/1
Qty/Box	45	45	45
Tidal volume (ml)	150-1500	150-1500	150-1500
Dead Space (ml)	80	55	55
Bacterial Efficiency	>99,9999%	>99,9999%	>99,9999%
Viral Efficiency	>99,999%	>99,999%	>99,999%
Resistance to Flow	30 L/min 4 mm/H ₂ O 60 L/min 17 mm/H ₂ O 90 L/min 32 mm/H ₂ O	30 L/min 9,5 mm H ₂ O 60 L/min 23,5 mm H ₂ O 90 L/min 42,5 mm H ₂ O	30 L/min 6,5 mm/H ₂ O 60 L/min 17 mm/H ₂ O 90 L/min 32,5 mm/H ₂ O
Weight (gr)	29,5	36	29,5
Fittings	22 mmM -15/22 mmMF	22 mmM-15/22 mmMF	22 mmM-15/22 mmMF
Humidification efficiency	33,6mgH ₂ O/L (@500 ml tid. vol.)	35 mgH ₂ O/L (@500 ml tid. vol.)	37,1 mgH ₂ O/L (@500 ml tid. vol.)

Bacterial Viral HME Filters

- Bacterial Efficiency %99.9999
- High level of moisture output
- Small and paediatric versions
- Coupled with a hydrophobic bacterial viral filter membrane
- Rounded ergonomic housing
- Sterile or Clean
- Standart Retainable Monitoring Cap
- High level of moisture output(>33mgH₂O/L)
- Hygroscopic cellulose or foam HME Media
- ISO Standart Connectors
- Individually Packed



BACTERIAL VIRAL HME FILTERS

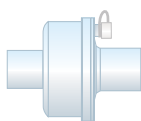

BACTERIAL-VIRAL/HME
Filter with paper

PP raw material

Code	AL-08022
Sterile Code	AL-080229
Qty/Box	50
Tidal volume (ml)	150-1500
Dead Space (ml)	55
Bacterial-Viral Efficiency	>99,9999%
Viral Efficiency	>99,999%
Resistance to Flow	30lt/min 8,2 mm H ₂ O 60lt/min 21,4 mm H ₂ O 90lt/min 39,5 mm H ₂ O
Weight (gr)	35,6
Fittings	22mmM - 15/22mmMF
Humidification efficiency	37 mg H ₂ O/L (@500 ml tid. vol.)

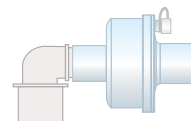

BACTERIAL-VIRAL/HME
Filter with foam HME

PP raw material

Code	AL-08021
Sterile Code	AL-080219
Qty/Box	50
Tidal volume (ml)	150-1500
Dead Space (ml)	55
Bacterial-Viral Efficiency	>99,9999%
Viral Efficiency	>99,999%
Resistance to Flow	30lt/min 6,5 mm H ₂ O 60lt/min 17,2 mm H ₂ O 90lt/min 33 mm H ₂ O
Weight (gr)	28,5
Fittings	22mmM - 15/22mmMF
Humidification efficiency	35,5 mg H ₂ O/L (@500 ml tid. vol.)

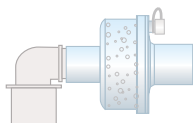

BACTERIAL-VIRAL/HME
Filter Angled with paper

PP raw material

Code	AL-08022/1
Sterile Code	AL-080229/1
Qty/Box	45
Tidal volume (ml)	150-1500
Dead Space (ml)	57
Bacterial-Viral Efficiency	>99,9999%
Viral Efficiency	>99,999%
Resistance to Flow	30lt/min 8,5 mm H ₂ O 60lt/min 21,5 mm H ₂ O 90lt/min 40 mm H ₂ O
Weight (gr)	41
Fittings	22mmM - 15/22mmMF
Humidification efficiency	37,5 mg H ₂ O/L (@500 ml tid. vol.)

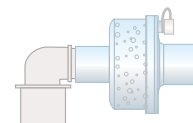

BACTERIAL-VIRAL/HME
Filter Angled with foam

PP raw material

Code	AL-08021/21
Sterile Code	AL-080219/1
Qty/Box	45
Tidal volume (ml)	150-1500
Dead Space (ml)	57
Bacterial-Viral Efficiency	>99,9999%
Viral Efficiency	>99,999%
Resistance to Flow	30lt/min 7 mm H ₂ O 60lt/min 17,5 mm H ₂ O 90lt/min 33,5 mm H ₂ O
Weight (gr)	34
Fittings	22mmM - 15/22mmMF
Humidification efficiency	36,5 mg H ₂ O/L (@500 ml tid. vol.)

Pediatric&Neonatal Filters



- Optimal filtration performance
- Flat ergonomic design
- Small and light weight
- Cost effective
- Gas sampling port
- Straight and Angled version
- Latex free
- Retainable cap.

PEDIATRIC & NEONATAL FILTERS

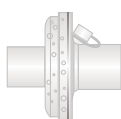

BACTERIAL VIRAL FILTER
PEDIATRIC

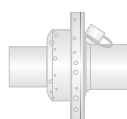

BACTERIAL VIRAL HME FILTER
PEDIATRIC



BACTERIAL VIRAL HME FILTER
NEONATAL

	SBC raw material	SBC raw material	SBC raw material
Code	AL-08030	AL-08031	AL-08032
Sterile Code	AL-080309	AL-080319	AL-080329
Qty/Box	100	100	100
Tidal volume (ml)	150-1200ml	75-300ml	70-600ml
Dead Space (ml)	37ml	30 ml	10 ml
Bacterial-Viral Efficiency	%99,9999	%99,9999	%99,9999
Viral Efficiency	%99,999	%99,999	%99,999
Resistance to Flow	30L/min - 7 mm H ₂ O	30L/min - 26 mm H ₂ O	30 L/min-6mm H ₂ O
Weight (gr)	19	21	15 gr
Fittings	22mmM - 15/22mmMF	22mmM - 15/22mmMF	22mmM - 15/22mmMF
Humidification efficiency	*	@250ml TV 33,6 mg H ₂ O/L	30mg H O/L(@50ml fid. vol.)

TRACHEOSTOMY HME

Tracheostomy HME



- Central port for suctioning & sampling
- Extreme low resistance
- Suitable for adult and children
- Recommended use; for patients over 15kg.
- Paper Media

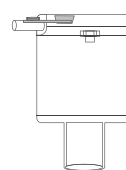

Tracheostomy
HME

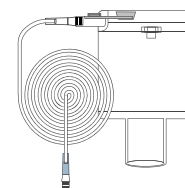

Tracheostomy
HME with Oxygen Tubing

	HME	HME with Oxygen Tubing
Code	AL-08025	AL-08026
Sterile Code	AL-080259	AL-080269
Qty/Box	100	50
Moisture exchange surf.	500 cm ²	500 cm ²
Dead Space (ml)	15	15
Humidification efficiency	1hr: 27,5mgH ₂ O/L 24hr: 28,8mgH ₂ O/L	1hr: 27,5mgH ₂ O/L 24hr: 28,8mgH ₂ O/L
Resistance to Flow initial	0.63 cmH ₂ O (30L/min) 1.8 cmH ₂ O (60 L/min) 3.5 cmH ₂ O (90 L/min)	0.63 cmH ₂ O (30L/min) 1.8 cmH ₂ O (60 L/min) 3.5 cmH ₂ O (90 L/min)
Weight (gr)	8,4	10
Connections	15F, oxygen port: 5,5mm, suctioning port: 6,1mm	15F, oxygen port: 5,5mm, suctioning port: 6,1mm



altech[®]

a Meditera Company

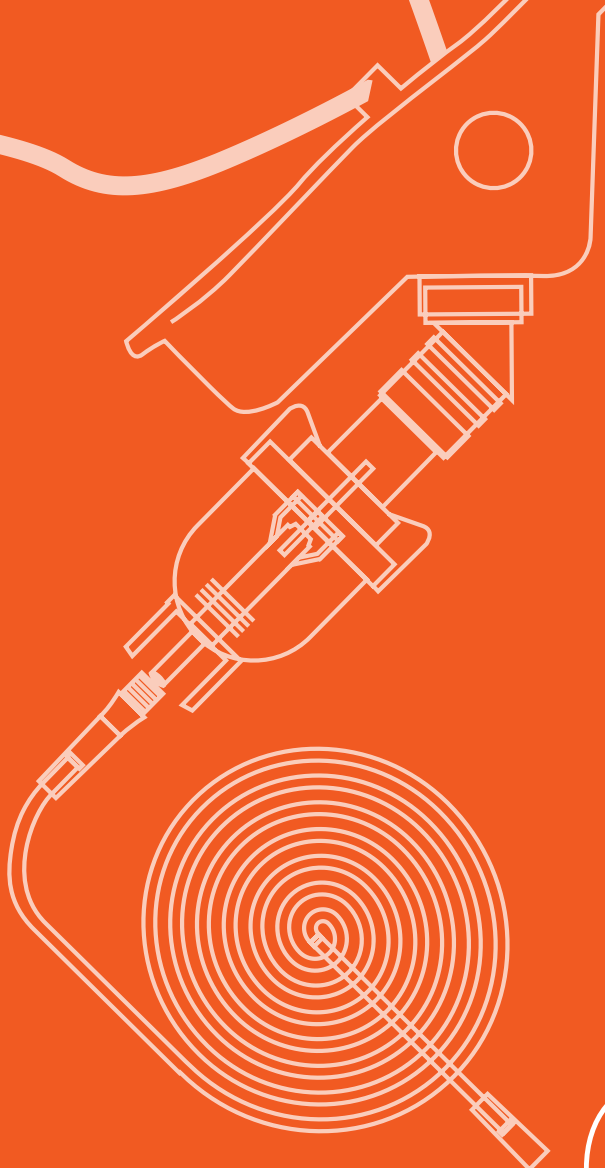

Oxygen
and aerosol
therapy
products

Oxygen and Aerosol Therapy Products



OXYGEN and AEROSOL THERAPY PRODUCTS

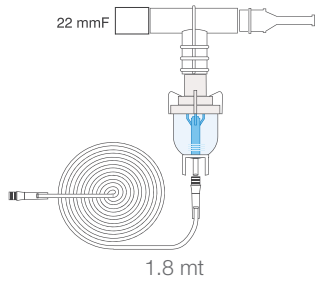

Description	Length	Code	Qty/Box
Flex hose, Nebulizer, Mouth piece, O₂ tubing	180 cm/71"	AL-30120	20/125

OXYGEN and AEROSOL THERAPY PRODUCTS

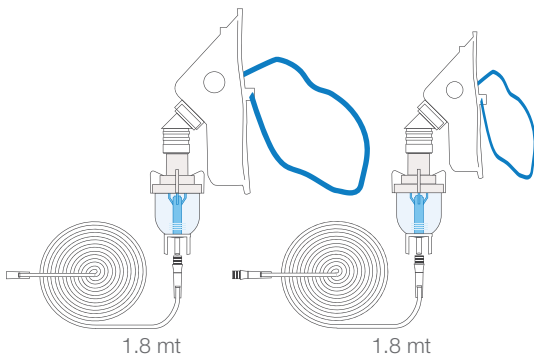

Description	Length	Code	Qty/Box
Adult, Nebulizer, Aerosol mask, O₂ tubing	180 cm/71"	AL-33210	20/125
Pediatric, Nebulizer, Aerosol dragon mask, O₂ tubing	180 cm/71"	AL-34210	20/150

Oxygen and Aerosol Therapy Products



OXYGEN and AEROSOL THERAPY PRODUCTS

Description	Length	Code	Qty/Box
Adult, Oxygen mask, 1,8 mt O₂ tubing	180 cm/71"	AL-31200	20/125
Pediatric, Oxygen mask, 1,8 mt O₂ tubing	180 cm/71"	AL-32200	20/150

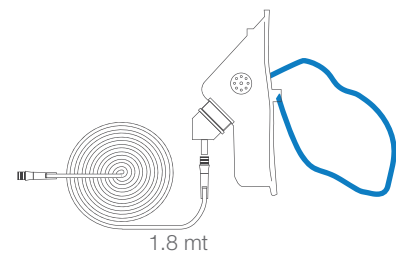

NON-REBREATHING MASK

Description	Length	Code	Qty/Box
Adult, High concentration, Non-rebreather mask, O₂ tubing	180 cm/71"	AL-35200	20/125
Pediatric, High concentration, Non-rebreather mask, O₂ tubing	180 cm/71"	AL-36200	20/150

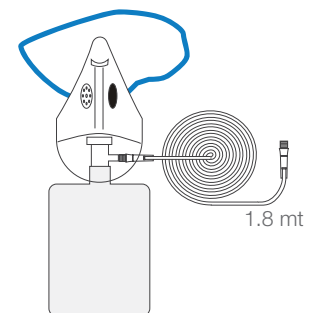

T CIRCUITS

Corrugated

	Length	Code	Qty/Box
Adult	160 cm/63"	AL-9111	100

Extendible with Port

	Length	Code	Qty/Box
Adult	160 cm/63"	AL-9313	100

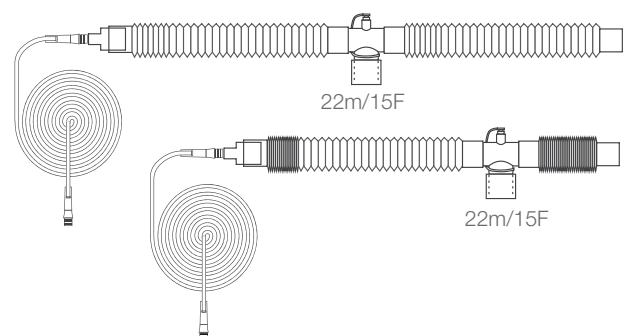



altech[®]

a Meditera Company

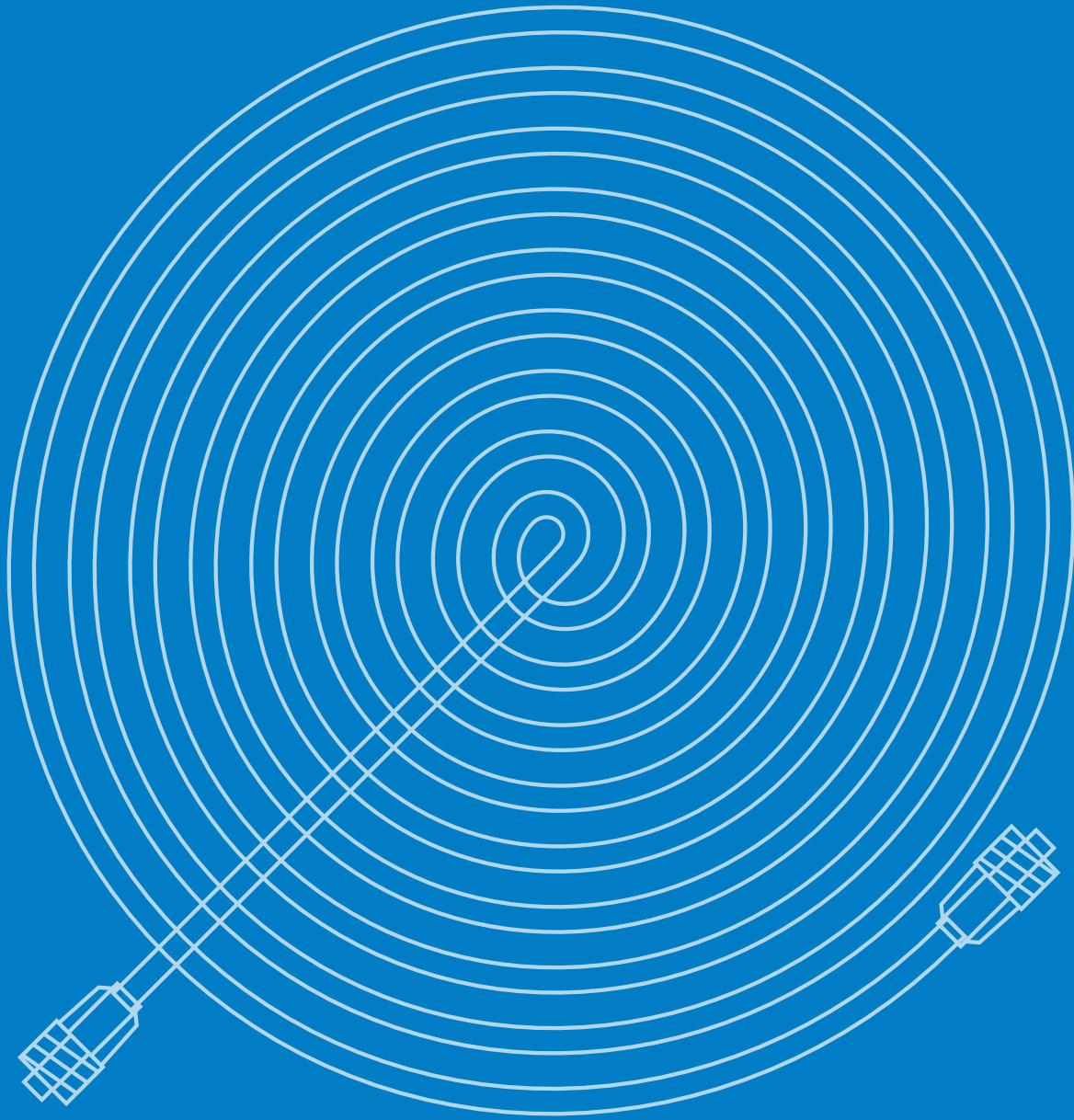

Gas
sampling lines

Gas Sampling Lines

- Disposable, Single Patient Use, medical grade tubing.
- Non-Sterile
- %100 Flow/occlusion Tested.
- Latex-Free



GAS SAMPLING LINES

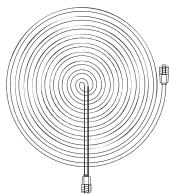

Description		Length	Code	Qty/Box
Gas Monitoring Lines	1,20 mmID X 2,80 mmOD Tubing male - male connector	3 m/118"	AL-0512	100
Gas Monitoring Lines	1,57 mmID X 3,17 mmOD Tubing male - male connector	3 m/118"	AL-0527	100

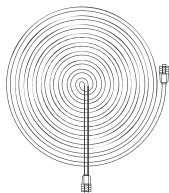

Description		Length	Code	Qty/Box
Gas Monitoring Lines	1,20 mmID X 2,80 mmOD Tubing male - male connector	2 m/79"	AL-0519	100
Gas Monitoring Lines	1,57 mmID X 3,17 mmOD Tubing male - male connector	2 m/79"	AL-0528	100

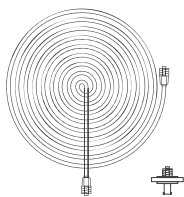

Description		Length	Code	Qty/Box
Gas Monitoring Lines + 0,5 micron filter	1,20 mmID X 2,80 mmOD Tubing male - male connector	3 m/118"	AL-0522	100

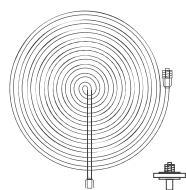

Description		Length	Code	Qty/Box
Gas Monitoring Lines + 0,5 micron filter	1,20 mmID X 2,80 mmOD Tubing male - female connector	3 m/118"	AL-0523	100

Gas Sampling Lines

- Gas sampling lines used to monitor CO, O, and NO levels.
- Optional filters for absorption of water and protection from particulates.
- 2 layer tubing to prevent diffusion of anesthetic gasses. (PE/PVC)
- Tubing lengths can be customized.



GAS SAMPLING LINES

Description	Length	Code	Qty/Box
Gas Monitoring Lines 1,20 mmID X 2,80 mmOD Tubing male - female connector	3 m/118"	AL-0513	100

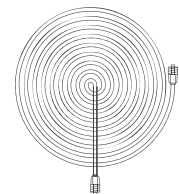

Description	Length	Code	Qty/Box
Gas Monitoring Lines 1,20 mmID X 2,80 mmOD Tubing male - female connector	2 m/79"	AL-0521	100

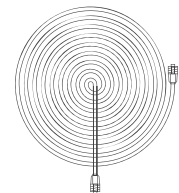

Description	Length	Code	Qty/Box
Gas Monitoring Lines 1,20 mmID X 2,80 mmOD Tubing male - female connector	2,5 m/98"	AL-0532	100

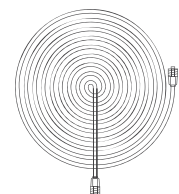



altech[®]

a Meditera Company



Masks & Resuscitators

Anesthesia Masks

- Color coded
- Standard & scented Mask Design Latex free
- Available in 6 different sizes for different indications
- Inflatable Cushion
- Transparent to allow easy observation



STANDART MASKS

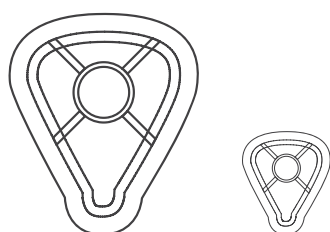

Description	Code	Size	Weight	Dead Space	Qty/Box
Respiratory, anesthesia mask #5	AL-09005	Large	55,5 gr	250 ml	25
Respiratory, anesthesia mask #4	AL-09004	Medium	51 gr	220 ml	25
Respiratory, anesthesia mask #3	AL-09003	Small	37,5 gr	180 ml	25
Respiratory, anesthesia mask #2	AL-09002	Child	27 gr	85 ml	50
Respiratory, anesthesia mask #1	AL-09001	Infant	17,5 gr	45 ml	60
Respiratory, anesthesia mask #0	AL-09000	Neonatal	14,5 gr	25 ml	60

PVC FREE MASKS

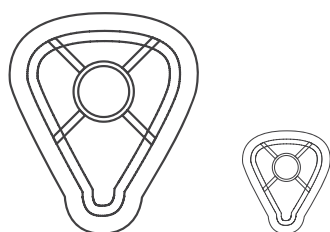

Description	Code	Product Description	Qty/Box
Respiratory, anesthesia mask #5 PVC Free	AL-09051	Large Adult	50
Respiratory, anesthesia mask #4 PVC Free	AL-09056	Medium Adult	50
Respiratory, anesthesia mask #3 PVC Free	AL-09055	Small Adult	50
Respiratory, anesthesia mask #2 PVC Free	AL-09054	Pediatric	75
Respiratory, anesthesia mask #1 PVC Free	AL-09053	Infant	75
Respiratory, anesthesia mask #0 PVC Free	AL-09052	Neonatal	75

SCENTED MASKS

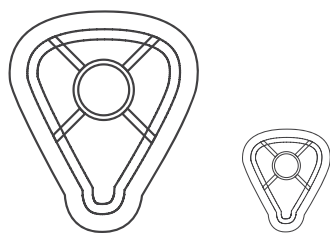

Description	Code	Size	Weight	Dead Space	Qty/Box
Respiratory, anesthesia mask #6	AL-09096	Ultra Large	59,5 gr	310 ml	20
Respiratory, anesthesia mask #5	AL-09095	Large	55,5 gr	250 ml	20
Respiratory, anesthesia mask #4	AL-09094	Medium	51 gr	220 ml	20
Respiratory, anesthesia mask #3	AL-09093	Small	37,5 gr	180 ml	20
Respiratory, anesthesia mask #2	AL-09092	Child	27 gr	85 ml	40
Respiratory, anesthesia mask #1	AL-09091	Infant	17,5 gr	45 ml	40
Respiratory, anesthesia mask #0	AL-09090	Neonatal	14,5 gr	25 ml	40

Oronasal NIV Masks

Designed to provide a good seal when fitted to the patient whilst providing maximum comfort.
 Safety valve for inspiration should the flow rate be insufficient or if the inspiratory line be occluded.
 Inflatable Cushion for perfect sealing
 Transparent design for visual inspection the patient



CPAP MASKS

Description	Code	Size	Weight	Dead Space	Qty/Box
CPAP Air Cushion Face Mask	AL-09014	Large Adult	67,5 gr	245 ml	20
CPAP Air Cushion Face Mask	AL-09016	Medium Adult	68,5 gr	215 ml	20

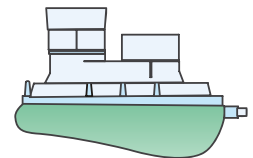

Description	Code	Size
Deluxe full face mask	AL-09058	Medium SW
Deluxe full face mask	AL-09059	Large SW
Deluxe full face mask	AL-09060	Small SW

- Latex-Free
- Scented
- Available in 3 sizes
- High Transparency
- Medical Grade PVC
- Offers high patient comfort
- Safety Valve on the mask

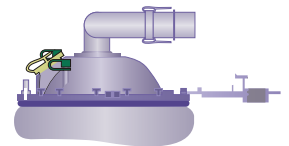

ACCESSORIES

CO2 exhalation connector

Code: 150.11.100

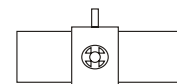

BVM RESUSCITATORS

- Medical grade PVC material.
- Disposable.
- Latex-Free
- 3 different sizes, Adult, Pediatric, Infant.
- Pressure Pop Off Valve
 - a. 60 cm H₀ for adult and ped.
 - b. 40 cm H₀ for neonates
- Suitable for Peep Valve connection with PEEP set
- ISO standart connectors.

BVM RESUSCITATOR LARGE, MASK, O2 TUBING

Qty/Box	Qty/Box
AL-0806-1/7	30

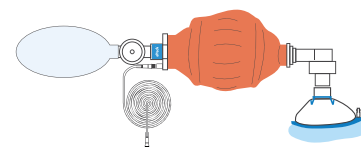

BVM RESUSCITATOR MEDIUM, MASK, O2 TUBING

Qty/Box	Qty/Box
AL-0807-1/7	40

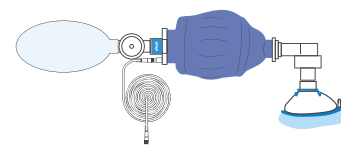

BVM RESUSCITATOR SMALL, MASK, O2 TUBING

Qty/Box	Qty/Box
AL-0808-1/7	50

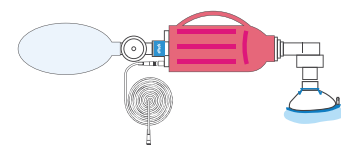



altech[®]

a Meditera Company

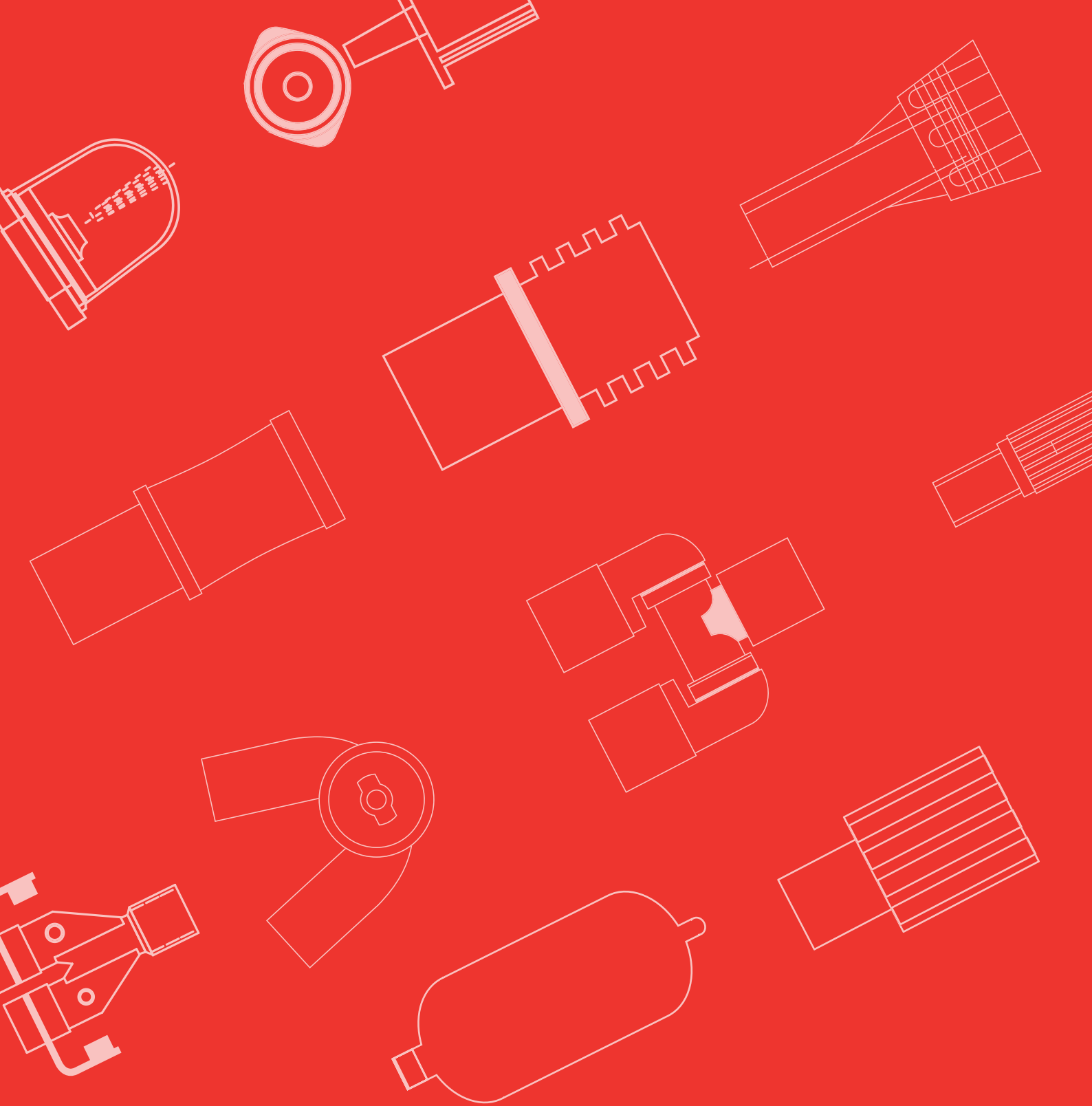

Accessories

Accessories



CONNECTORS / WATER TRAPS and PARTS

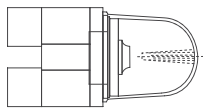

22 mm NEO WATER TRAP PP

CODE: 151.33.007.008
QTY/Box: 300

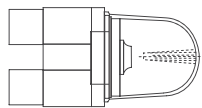

19 mm NEO WATER TRAP PVC

CODE: 151.33.070.008
QTY/Box: 300

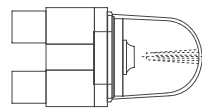

15 mm NEO WATER TRAP PP

CODE: 151.33.077.008
QTY/Box: 300

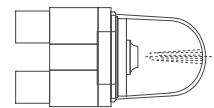

15 mm NEO WATER TRAP PP

CODE: 151.33.077.008.01
QTY/Box: 300

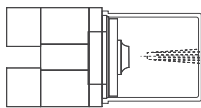

22 mm WATER TRAP PP

CODE: 151.33.007.078
QTY/Box: 300

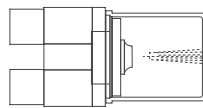

19 mm WATER TRAP PVC

CODE: 151.33.070.078
QTY/Box: 300

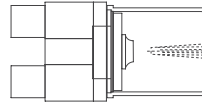

15 mm WATER TRAP PVC

CODE: 151.33.077.078
QTY/Box: 300

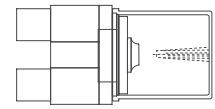

15 mm WATER TRAP PP

CODE: 151.33.077.008.02
QTY/Box: 300

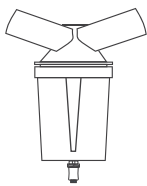

22MM Angled Needle Free Inkwell Water Trap PP

CODE: 151.33.184.185
QTY/Box: 300

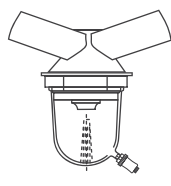

22MM Angled Needle Free Water Trap PP

CODE: 151.33.184.223
QTY/Box: 300

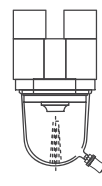

22MM Needle Free Water Trap PP

CODE: 151.33.007.223
QTY/Box: 300

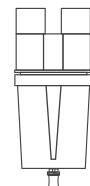

22 MM Needle Free Inkwell Water Trap PP

CODE: 151.33.007.185
QTY/Box: 300

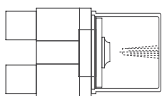

10mm NEONATAL WATER TRAP-PP

CODE: 151.33.777.078
QTY/Box: 300

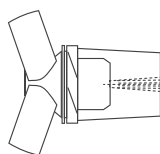

22 mm WATER TRAP PP

CODE: 150.11.070
QTY/Box: 300

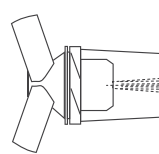

15 mm WATER TRAP PP

CODE: 150.11.071
QTY/Box: 300

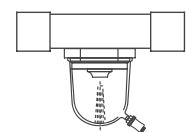

Device Side Needle Free Water Trap PP

CODE: 151.33.222.223
QTY/Box: 300

Accessories



Connectors / Y&T & Elbow

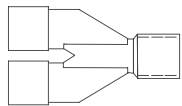

22 mm PARALLEL
Y CONNECTOR PP
NEO

CODE: 151.03.150.02
QTY/Box: 1000

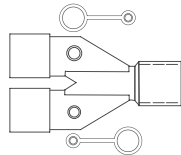

22 mm PARALLEL
Y CONNECTOR
with 2 PORTS with
CAPS-PP

CODE: 151.33.087 QTY/
Box: 1000

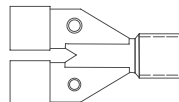

22 mm PARALLEL
Y CONNECTOR
with 2 PORTS - PP NEO

CODE: 151.03.150.01
QTY/Box: 1000

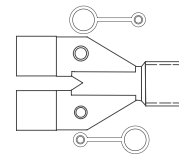

19 mm PARALLEL
Y CONNECTOR
with 2 PORTS with CAPS-
PVC

CODE: 151.33.109
QTY/Box: 1000

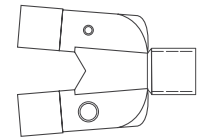

22MM ANGLED
Y CONNECTOR FOR MDI
CHAMBER PP

CODE: 151.03.225
QTY/Box: 1000

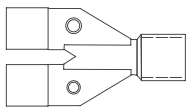

19 mm PARALLEL
Y CONNECTOR
with 2 PORTS - PVC

CODE: 151.03.109.01
QTY/Box: 1000

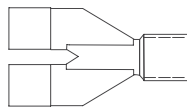

19 mm PARALLEL
Y CONNECTOR
PVC

CODE: 151.03.109.02
QTY/Box: 1000



NEONATAL Y CONNECTOR
with temp, connector and proximal
pressure line connector - SBC

CODE: 151.03.131
QTY/Box: 2500

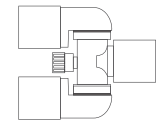

22 mm SWIVEL
Y CONNECTOR
with PORT-PP

CODE: 150.11.084
QTY/Box: 2500

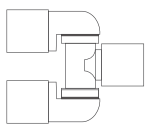

22 mm SWIVEL
Y CONNECTOR
without PORT-PP

CODE: 150.11.097
QTY/Box: 2500

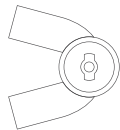

NEONATAL
Y CONNECTOR
WITH CO, PORT without Cap

CODE: 150.11.032
QTY/Box: 2500

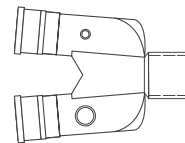

22MM Y CONNECTOR
ANGLED WITH PORT

CODE: 151.03.188
QTY/Box: 1000

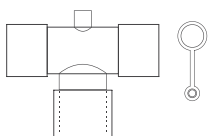

22mm, 22/15 mm
TCONNECTOR
with PORT with CAP

CODE: 150.33.033
QTY/Box: 1200

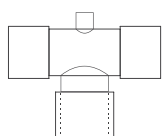

22mm, 22/15 mm
TCONNECTOR
with PORT

CODE: 150.11.031
QTY/Box: 1200

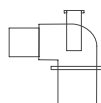

ELBOW CONNECTOR with
CO2 PORT - PP

CODE: 151.03.085.01
QTY/Box: 4000

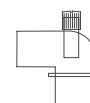

ELBOW CONNECTOR
with LUER-LOCK with CO2
PORT-PP

CODE: 151.33.085
QTY/Box: 4000

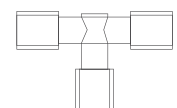

10 mm, 10mm/10mm
T CONNECTOR, SBC

CODE: 151.03.032
QTY/Box: 1200

Accessories



CONNECTORS / STRAIGHT

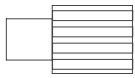

15M-22F STRAIGHT
CONNECTOR-EVA

CODE: 151.03.084
QTY/Box: 4000

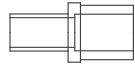

15M-22M/15F STRAIGHT
CONNECTOR-SBC

CODE: 151.03.113.02
QTY/Box: 4000

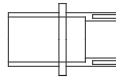

22M-22M/15F STRAIGHT
CONNECTOR - PP

CODE: 151.03.110
QTY/Box: 4000

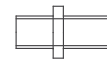

15M-15M STRAIGHT
CONNECTOR-SBC

CODE: 151.03.113.01
QTY/Box: 4000



22M-22F STRAIGHT
CONNECTOR-EVA

CODE: 151.03.001
QTY/Box: 3000

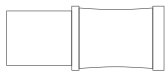

22M-22F STRAIGHT
CONNECTOR-PVC

CODE: 151.03.122
QTY/Box: 3000

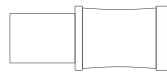

15M-22F STRAIGHT
CONNECTOR - PVC

CODE: 150.11.078
QTY/Box: 3000

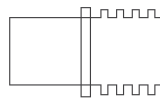

ADU CONNECTOR PP

CODE: 151.03.088
QTY/Box: 3000

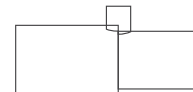

22M-22F STRAIGHT
CONNECTOR
with TEMPERATURE
PORT-PP

CODE: 150.11.133
QTY/Box: 2400

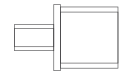

10M-22F STRAIGHT
CONNECTOR - SBC

CODE: 151.03.128
QTY/Box: 2400

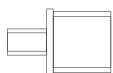

10M-22M STRAIGHT
CONNECTOR - SBC

CODE: 151.03.134
QTY/Box: 2400



7M-10M STRAIGHT
CONNECTOR - SBC

CODE: 151.03.137
QTY/Box: 2400



10M-1 OF STRAIGHT
CONNECTOR-SBC

CODE: 151.03.140
QTY/Box: 2400



10M-10F STRAIGHT
CONNECTOR
for SLE Ventilators Only
- SBC

CODE: 151.03.116
QTY/Box: 2400



10M-15F STRAIGHT
CONNECTOR - SBC

CODE: 151.03.135
QTY/Box: 2400



15M-15F STRAIGHT
CONNECTOR -
SBC

CODE: 151.03.219
QTY/Box: 2400

Accessories



CONNECTORS / STRAIGHT

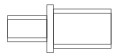

10M-15M STRAIGHT CONNECTOR - SBC

CODE: 151.03.136
QTY/Box: 2400

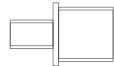

10M/15F NEONATAL STRAIGHT CONNECTOR

CODE: 150.11.013
QTY/Box: 2400

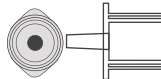

15-6 MM STRAIGHT CONNECTOR

CODE: 150.11.040
QTY/Box: 2400

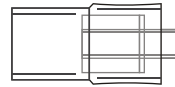

22F-10 MM STRAIGHT CONNECTOR PVC

CODE: 150.11.076
QTY/Box: 2400

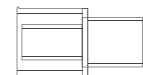

11F-10MM STRAIGHT CONNECTOR PVC

CODE: 150.11.077
QTY/Box: 2400



22M - 22F STRAIGHT CONNECTOR-PP

CODE: 151.03.146
QTY/Box: 2400

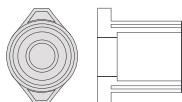

SWIVEL CATHETER MOUNT 22 MM CONNECTOR-SBC

CODE: 151.03.104
QTY/Box: 2400



SWIVEL CATHETER MOUNT 15 MM CONNECTOR-SBC

CODE: 151.03.105
QTY/Box: 2400



02 TUBING CONNECTOR PVC

CODE: 151.03.097
QTY/Box: 2400

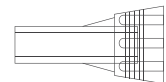

02 TUBING THREADED NUT CONNECTOR PVC

CODE: 151.03.099
QTY/Box: 2400

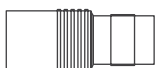

22M - 22F STRAIGHT CONNECTOR-PP FOR CORRUGATED

CODE: 151.03.221
QTY/Box: 2400

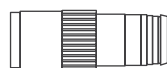

22M - 22F STRAIGHT CONNECTOR-PP FOR EXTENDIBLE

CODE: 151.03.220
QTY/Box: 2400

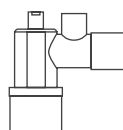

15F-15M/22F ELBOW WITH DOUBLE PORT

CODE: 151.03.218.02
QTY/Box: 2400

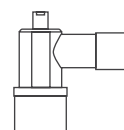

15F-15M/22F ELBOW WITH LUER PORT

CODE: 151.03.218.01
QTY/Box: 2400

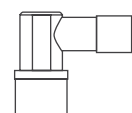

15F-15M/22F ELBOW W/O PORT

CODE: 151.03.218
QTY/Box: 2400

Accessories



CONNECTORS / OTHER

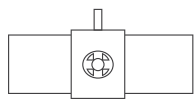

EXHAUST CONNECTOR
SBC

CODE: 150.11.100
QTY/Box: 2400

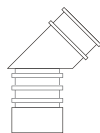

AEROSOL MASK
CONNECTOR PP

CODE: 151.03.096
QTY/Box: 10000

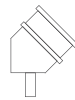

OXYGEN MASK
CONNECTOR PP

CODE: 151.03.095
QTY/Box: 10000

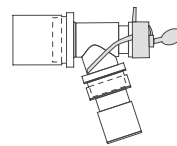

SWIVEL CATHETER
MOUNT

CODE: 1000
QTY/Box: 8000

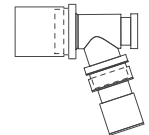

CLOSED SWIVEL
CATHETER MOUNT
BODY PART

CODE: 151.03.103
QTY/Box: 8000

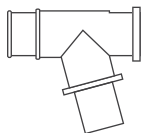

SWIVEL CATHETER
MOUNT
BODY-PE NEO

CODE: 151.03.151
QTY/Box: 8000

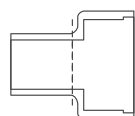

STRAIGHT
CONNECTOR
FOR DOUBLE PORT
CPAP MASK-EVA

CODE: 151.03.026
QTY/Box: 1600



NEWPORT CONNECTOR
PP

CODE: 151.03.075.01
QTY/Box: 8000

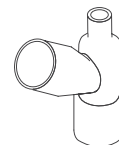

HEATED WIRE ADAPTOR
PP

CODE: 150.11.024
QTY/Box: 1600

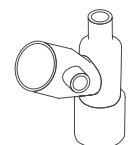

HEATED WIRE
ADAPTOR
with PORT - PP

CODE: 150.11.023
QTY/Box: 1600

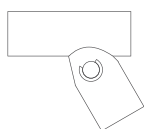

HEATING WIRE
CONNECTOR

CODE: 151.03.145
QTY/Box: 1600



Y CONNECTOR HEATED
WIRE PORT -PP

CODE: 151.03.075.02
QTY/Box: 20.000

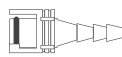

COLDER
CONNECTOR

CODE: 150.11.096
QTY/Box: 20.000

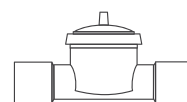

IPPB
CONNECTOR

CODE: 150.11.015
QTY/Box: 600

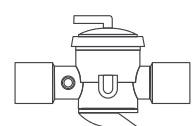

IPPB CONNECTOR
with PORT

CODE: 150.11.014
QTY/Box: 400

Accessories



CONNECTORS / STRAIGHT



**IPPB PORT
PP**

CODE: 151.03.075.03
QTY/Box: 20.000

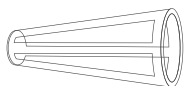

**BREATHING BAG CONICAL
CONNECTOR**

CODE: 151.03.133
QTY/Box: 20.000

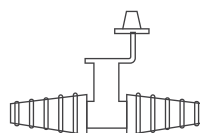

**ASPIRATION TUBING FINGER
TIP CONTROLLED**

CODE: 151.03.098
QTY/Box: 8000



**ASPIRATION TUBING
CONNECTOR PVC**

CODE: 151.03.098
QTY/Box: 8000



**LONG CONNECTOR
CAP RED - PE**

CODE: 151.03.021.01
QTY/Box: 10000



**NEONATAL RED
CAP PE**

CODE: 150.11.226
QTY/Box: 10000



**TUBE CUB
with ONE HOLDER PE**

CODE: 151.03.022
QTY/Box: 12.000

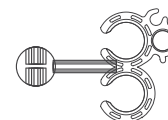

**TUBE CLIP
with TWO HOLDERS PE**

CODE: 151.03.023
QTY/Box: 3200

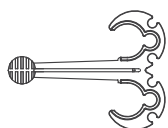

**TUBE CLIP
with TWO HOLDERS PE**

CODE: 151.03.081
QTY/Box: 1600



**Y CONNECTOR
CAP CAWITON**

CODE: 151.03.074
QTY/Box: 20.000



**NEONATAL Y and
T CONNECTOR CAP PP**

CODE: 151.03.138
QTY/Box: 20.000



**ELBOW CONNECTOR
CAP CAWITON**

CODE: 151.03.100
QTY/Box: 20.000

Accessories

Flexibility – Corrugated Tube (Polyethylene)

- Lightweight and cost effective
- Directly bonded connectors to the tube for avoiding leakage risks
- Available in White and Blue Color

Smooth Inside – Smoothbore Tube

- Lower tubing compliance
- Transparent tube makes viewing tube inside easier
- Inner smooth surface allows easy drainage of condensed water and contributes to reduce the risk of interruptions in anesthesia,
- Soft, flexible connectors ensure a perfect seal with anesthesia machine inlet and outlet

Adjust&Extend – Polypropylene (PP) Extendible Tube

- Extendible tubes may be extended up to 3 times their packed length and allow system to be set to the desired length and position optimising the compressible volume
- Extendible tubings maintain their position set by healthcare professional as long as desired thus minimise the strain on the airway connection
- Available in adult 22mm and pediatric 15mm sizes



TUBINGS

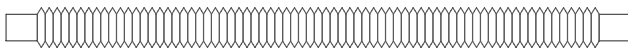

15 mm CORRUGATED TUBING ROLLS 50 MT

151.05.01.101	PE	20 cm/8"	CUFF
151.05.01.102	PE	30 cm/12"	CUFF
151.05.01.103	PE	60 cm/24"	CUFF
151.05.01.104	PE	80 cm/32"	CUFF
151.05.01.105	PE	90 cm/36"	CUFF
151.05.01.106	PE	100 cm/40"	CUFF
151.05.01.107	PE	160 cm/63"	CUFF

15 mm CORRUGATED TUBING READY CUT

151.05.01.151	PE	60 cm/24"	CUFF
151.05.01.152	PE	80 cm/32"	CUFF
151.05.01.153	PE	90 cm/36"	CUFF
151.05.01.154	PE	100 cm/40"	CUFF
151.05.01.155	PE	160 cm/63"	CUFF

22 mm CORRUGATED TUBING ROLLS 50 mt

151.05.01.000	PE	20 cm/8"	CUFF
151.05.01.001	PE	30 cm/12"	CUFF
151.05.01.002	PE	60 cm/24"	CUFF
151.05.01.003	PE	80 cm/32"	CUFF
151.05.01.004	PE	90 cm/36"	CUFF
151.05.01.005	PE	100 cm/40"	CUFF
151.05.01.006	PE	160 cm/63"	CUFF

22 mm CORRUGATED TUBING READY CUT

151.05.01.051	PE	60 cm/24"	CUFF
151.05.01.052	PE	80 cm/32"	CUFF
151.05.01.053	PE	90 cm/36"	CUFF
151.05.01.054	PE	100 cm/40"	CUFF
151.05.01.055	PE	160 cm/63"	CUFF

10 mm CORRUGATED TUBING READY CUT

151.05.01.300	PE	160 cm/63"	CUT
151.05.01.301	PE	110 cm/43"	CUT
151.05.01.302	PE	90 cm/35"	CUT
151.05.01.303	PE	180 cm/70"	CUT
151.05.01.304	PE	150 cm/59"	CUT
151.05.01.305	PE	60 cm/24"	CUT
151.05.01.306	PE	20 cm/8"	CUFF
151.05.01.308	PE	28 cm/11"	CUFF
151.05.01.310	PE	26 cm/10"	CUFF
151.05.01.312	PE	80 cm/31"	CUT



TUBINGS

22 mm EXTENDIBLE TUBINGS

151.05.02.201	75 cm/' 30"
151.05.02.202	90 cm/' 36"
151.05.02.203	150 cm/' 59"
151.05.02.204	180 cm/' 71"

15 mm EXTENDIBLE TUBINGS

151.05.02.251	15 cm/' 6"
151.05.02.252	75 cm/' 30"
151.05.02.253	90 cm/' 36"
151.05.02.254	150 cm/' 59"
151.05.02.255	180 cm/' 71"

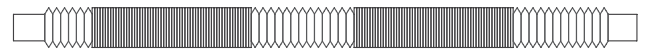

SMOOTH-BORE TUBINGS

22 mm SMOOTHBORE TUBING (PVC Free) ADULT

152.05.04.022	30 CM	CUT
152.05.04.021	40 CM	CUT
152.05.04.018	45 CM	CUT
152.05.04.002	55 CM	CUT
152.05.04.012	75 CM	CUT
152.05.04.003	85 CM	CUT
152.05.04.014	95 CM	CUT
152.05.04.004	115 CM	CUT
152.05.04.005	145 CM	CUT
152.05.04.011	155 CM	CUT
152.05.04.006	175 CM	CUT
152.05.04.016	195 CM	CUT
152.05.04.023	225 CM	CUT
152.05.04.007	245 CM	CUT
152.05.04.019	295 CM	CUT

15 mm SMOOTHBORE TUBING (PVC Free) PEDIATRIC

152.05.04.036	10 CM	CUT
152.05.04.037	15 CM	CUT
152.05.04.038	20 CM	CUT
152.05.04.024	55 CM	CUT
152.05.04.025	75 CM	CUT
152.05.04.031	85 CM	CUT
152.05.04.026	115 CM	CUT
152.05.04.027	145 CM	CUT
152.05.04.028	175 CM	CUT
152.05.04.029	210 CM	CUT

10 mm SMOOTHBORE TUBING (PVC Free) NEONATAL

152.05.04.039	5 CM	CUT
152.05.04.040	10 CM	CUT
152.05.04.041	15 CM	CUT
152.05.04.042	55 CM	CUT
152.05.04.043	75 CM	CUT
152.05.04.044	145 CM	CUT
152.05.04.045	155 CM	CUT

19 mm SMOOTHBORE TUBING (PVC Free) ADULT

152.05.04.046	30 CM	CUT
152.05.04.047	40 CM	CUT
152.05.04.048	45 CM	CUT
152.05.04.049	55 CM	CUT
152.05.04.050	75 CM	CUT
152.05.04.051	85 CM	CUT
152.05.04.052	95 CM	CUT
152.05.04.053	115 CM	CUT
152.05.04.054	145 CM	CUT
152.05.04.055	155 CM	CUT
152.05.04.055	175 CM	CUT
152.05.04.057	195 CM	CUT
152.05.04.058	225 CM	CUT
152.05.04.059	245 CM	CUT
152.05.04.060	295 CM	CUT



Accessories

Flexibility – Corrugated Tube (Polyethylene)

Vast majority of our breathing circuits are made of corrugated polyethylene tubing. Lightweight and cost effective.

Smooth Inside – Smoothbore Tube.

Lower tubing compliance. Transparent tube makes easy monitoring of the tube inside.

Adjust&Extend – Polypropylene (PP) Extendible Tube.

Extendible tubes are manufactured using polypropylene PP allowing system to be set to the desired length and position optimising the compressible volume.



TUBINGS

19 mm SMOOTHBORE TUBING PVC WITH CONNECTOR

152.05.04.022	30 CM	CUT
152.05.04.021	40 CM	CUT
152.05.04.018	45 CM	CUT
152.05.04.002	55 CM	CUT
152.05.04.012	75 CM	CUT
152.05.04.003	85 CM	CUT
152.05.04.014	95 CM	CUT
152.05.04.004	115 CM	CUT

152.05.04.005	145 CM	CUT
152.05.04.011	155 CM	CUT
152.05.04.006	175 CM	CUT
152.05.04.016	195 CM	CUT
152.05.04.023	225 CM	CUT
152.05.04.007	245 CM	CUT
152.05.04.019	295 CM	CUT

15 mm SMOOTHBORE TUBING PVC WITH CONNECTOR

151.05.030	75 cm/' 30"	CUT
151.05.031	100 cm/' 40"	CUT
151.05.032	150 cm/' 59"	CUT

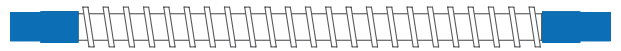

LATEX BREATHING BAGS

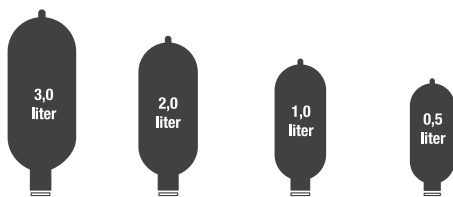

Code	AL-07004	AL-07003	AL-07002	AL-07001
Qty/Box	50	50	100	100

NON-LATEX (NEOPRENE) BREATHING BAGS

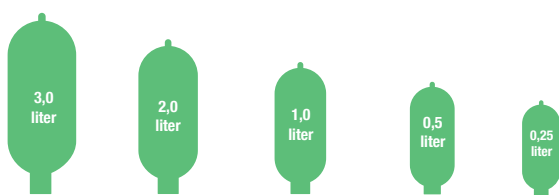

Code	AL-07010	AL-07009	AL-07008	AL-07007	AL-07006
Qty/Box	50	50	100	100	100



EC Certificate
Directive 93/42/EEC Annex V
Production Quality Assurance
Medical Devices

Registration No.: DD 60103525 00D1
Report No.: 28225744 001

Manufacturer:
ALTERA TIBBI
MALZEME SAN. VE TIC. A.Ş.
İbni Miskek OSB MH, Tosbi Yol 4 SK, NO:29
35900 Tire-Izmir
Turkey.

Products:
sterile and non-sterile breathing and infusion systems
(see attachment for details)
Replacement Certificates, Registration No.: DD 60032786 001

Expiry Date: 2024-04-28

The Notified Body hereby declares that the requirements of Annex V of the directive 93/42/EEC have been met for the listed products. The above named manufacturer has established and applies a quality assurance system, which is subject to periodic surveillance, defined by Annex V, section 4 of the aforementioned directive. For placing on the market of class III and class III devices covered by this certificate an EC type-examination certificate according to Annex II is required.

Effective Date: 2015-07-31
Date: 2015-07-31

Notified Body
Dr. K. Kluge

TÜV Rheinland LGA Products GmbH - Tillystraße 2 - 90431 Nürnberg

TÜV Rheinland LGA Products GmbH is a Notified Body according to Directive 93/42/EEC concerning medical devices with the identification number 6192.



Certificate
The Certification Body of
TÜV Rheinland LGA Products GmbH

herby certifies that the organization
ALTERA TIBBI
MALZEME SAN. VE TIC. A.Ş.
İbni Miskek OSB MH, Tosbi Yol 4 SK, NO:29
35900 Tire-Izmir
Turkey

has established and applies a quality management system for medical devices for the following scope:

Design and Development, Manufacture, Distribution and Sterilization of medical devices (see attachment for details)

Proof has been furnished that the requirements specified in

**EN ISO 13485:2012
EN ISO 13485:2012/AC:2012**

are fulfilled. The quality management system is subject to yearly surveillance.

Effective Date: 2015-07-31
Certificate Registration No.: BX 80103522 0001
An audit was performed, Report No.: 28225744 001
This Certificate is valid until: 2018-04-15

Certification Body



Date: 2015-07-31

TÜV Rheinland LGA Products GmbH - Tillystraße 2 - 90431 Nürnberg
Tel.: +49 (0) 910 127 1-140, +49 (0) 910 405 405, www.tuev.com



Certificate
The Certification Body of
TÜV Rheinland LGA Products GmbH

herby certifies that the organization
ALTERA TIBBI
MALZEME SAN. VE TIC. A.Ş.
İbni Miskek OSB MH, Tosbi Yol 4 SK, NO:29
35900 Tire-Izmir
Turkey

has established and applies a quality management system for the following scope:

Design and development, manufacture, distribution and sterilization of medical devices

Proof has been furnished that the requirements specified in

EN ISO 9001:2008

are fulfilled. The quality management system is subject to yearly surveillance.

Effective Date: 2015-07-31
Certificate Registration No.: BY 80103523 0001
An audit was performed, Report No.: 28225744 001
This Certificate is valid until: 2018-04-15

Certification Body
Dr. K. Kluge

Date: 2015-07-31

TÜV Rheinland LGA Products GmbH - Tillystraße 2 - 90431 Nürnberg
Tel.: +49 (0) 910 127 1-140, +49 (0) 910 405 405, www.tuev.com

Certificate

Standard: **ISO 14001:2004**

Certificate Registr. No.: 01 104 067407

TÜV Rheinland Cert GmbH certifies:

Certificate Holder: **ALTERA TIBBI MALZEME SAN. TIC. A.Ş.**
İbni Miskek Mh. OSB Tosbi Yol 4 Sok. No:29-31
Tire-Izmir-Turkey

Scope: **Design, Development, Manufacturing and Distribution of Medical Devices**

An audit was performed, Report No. 067407. Proof has been furnished that the requirements according to ISO 14001:2004 are fulfilled.
The due date for all future audits is 20-12 (dd.mm).

Validity: The certificate is valid from 2014-01-14 until 2017-01-11.
First certification 2011

2014-01-14

TÜV Rheinland Cert GmbH
Am Grünen Baum 1
10585 Berlin

DGA-ZM 58-95-60

www.tuv.com 



altech®

a Meditera Company

altech®

Breathing Systems

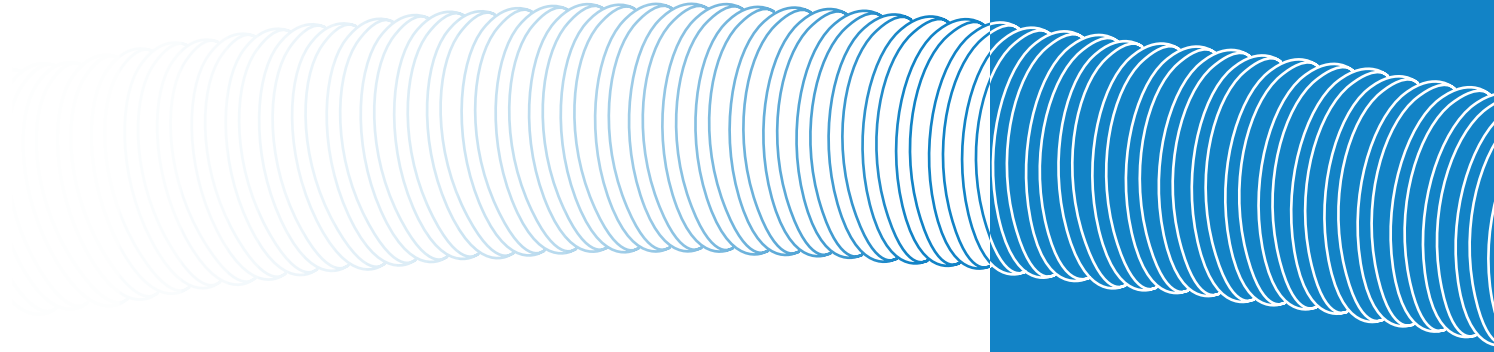

Factory

Adress: Tire Organize Sanayi Bölgesi, Tire 35900 IZMIR / TURKEY

Telephone: +90 232 513 51 10 (pbx) **Fax:** +90 232 513 51 14

Headquarter

Adress: 5758 Sk. No: 4/C Kat: 2-3 Karabağlar - IZMIR / TURKEY

Telephone: +90 232 237 59 49 (pbx) **Fax:** +90 232 253 94 04

info@altech.com.tr

www.altech.com.tr

a Meditera Company

August 2015

Ver.: 1